

SERVICE MANUAL

USE

SIGMA CONTROL

Index: BUB 07

GL-No.: 7_7000_0-00 05

1	Technical specification	1 – 1
1.1	Power Supply	1 – 1
1.2	Sensors	1 – 1
1.3	Hardware	1 – 1
1.3.1	Interface pin connections	1 – 2
1.3.1.1	RS 232	1 – 2
1.3.1.2	RS 485	1 – 2
1.3.1.3	Profibus	1 – 2
1.4	Software	1 – 3
2	Safety Regulations	2 – 4
2.1	Explanation of Symbols and Instructions	2 – 4
2.2	General Instructions	2 – 5
2.3	Safety Regulations for the Controller	2 – 5
3	General	3 – 6
3.1	Short Description	3 – 6
3.2	Finding the best Type of Pressure Regulation	3 – 7
3.3	DUAL Control	3 – 8
3.4	QUADRO Control	3 – 9
3.5	VARIO Control	3 – 10
4	Operation	4 – 11
4.1	Control Panel	4 – 11
4.2	The SIGMA CONTROL System	4 – 11
4.3	EMERGENCY STOP Pushbutton	4 – 11
4.3.1	Function keys	4 – 12
4.3.2	Key functions	4 – 13
4.3.3	Light emitting diodes and plain text display	4 – 14
4.3.4	LED functions	4 – 15
4.3.4.1	Display	4 – 16
4.4	Switching the Compressor Package On and Off	4 – 18
4.4.1	Switching on locally	4 – 18
4.4.2	Switching off locally	4 – 18
4.4.3	Switching on and off in remote	4 – 18
4.4.4	Switching on and off with the clock	4 – 18
4.5	Resetting Alarm Messages	4 – 19
4.6	Acknowledgement of Warning Messages	4 – 19
4.7	Alarm and Warning Messages	4 – 20
4.8	Frequently Programmed Functions	4 – 30
4.8.1	Procedure for initial startup (Standard Mode)	4 – 30
4.8.2	Procedure for initial startup (Expert Mode)	4 – 33
4.8.3	Correcting the package pressure	4 – 40
4.8.4	Carrying out maintenance	4 – 43

	Chapter – Page
4.8.5	The compressor package is to be operated with a base load sequencer ... 4 – 45
4.8.5.1	MIC 4000 as an example 4 – 45
4.8.5.2	MVS 8000 as an example 4 – 49
4.8.5.3	VESIS/SAM as an example 4 – 56
4.8.6	Two rotary screw compressors in sequence 4 – 65
4.8.6.1	Base load sequencing of two compressor packages with SIGMA CONTROL via the RS 485 interface 4 – 65
4.8.6.1.1	Settings on both SIGMA CONTROLS 4 – 68
4.8.6.1.2	Settings on the master SIGMA CONTROL 4 – 70
4.8.6.1.3	Settings on the slave SIGMA CONTROL 4 – 72
4.8.6.1.4	Settings on both SIGMA CONTROLS 4 – 73
4.8.6.2	Sequencing SIGMA and pressure switch controlled compressors 4 – 74
5	SIGMA CONTROL Menus 5 – 79
5.1	Main Menu 5 – 79
5.2	Password Protection 5 – 81
5.3	Display and Setup Level 5 – 82
5.4	Display Level 5 – 82
6	Display Level in SIGMA CONTROL 6 – 86
6.1	Status Data 6 – 86
6.1.1	Messages 6 – 87
6.1.2	Statistics 6 – 88
6.1.3	Print 6 – 90
6.1.3.1	Printer clock 6 – 91
6.2	Analog data 6 – 92
6.3	Operating data 6 – 94
6.4	Maintenance 6 – 96
6.4.1	Setting/resetting the maintenance interval counter 6 – 98
7	Display and Setup Level 7 – 100
7.1	Password 7 – 100
7.1.1	Enter password 7 – 101
7.2	Clock 7 – 102
7.2.1	General description of the clock 7 – 104
7.2.1.1	The daily schedule 7 – 104
7.2.1.2	The weekly schedule 7 – 105
7.2.1.3	The yearly schedule 7 – 105
7.2.1.4	Clock key 7 – 107
7.3	Configuration 7 – 108
7.3.1	General 7 – 109
7.3.2	Pressure settings 7 – 112
7.3.2.1	Compressor configuration 7 – 112
7.3.2.1.1	System pressure 7 – 112
7.3.2.2	Vacuum package 7 – 114
7.3.2.2.1	System pressure of the vacuum package 7 – 114
7.3.2.3	Load control 7 – 115

	Chapter – Page
7.3.3 Control mode	7 – 118
7.3.3.1 DUAL Control settings (normal control)	7 – 118
7.3.3.2 QUADRO control settings	7 – 118
7.3.3.3 Modulating control	7 – 119
7.3.4 Acknowledgement (reset)	7 – 120
7.3.5 Compressor start	7 – 121
7.3.6 I/O periphery	7 – 123
7.3.6.1 timer	7 – 125
7.4 Components	7 – 126
7.4.1 Motor	7 – 127
7.4.1.1 Power switching	7 – 127
7.4.2 Oil circulation	7 – 127
7.4.2.1 Oil separator	7 – 127
7.4.3 Booster	7 – 128
7.4.4 Air main charging	7 – 128
7.4.5 Package discharge temperature	7 – 129
7.5 Package Test	7 – 130
7.5.1 Compressor test	7 – 131
7.5.2 TÜV check	7 – 131
7.5.2.1 Pressure relief valve	7 – 131
7.5.2.2 Temperature sensor / shutdown temperature	7 – 132
7.5.3 Binary input/output check	7 – 132
7.5.4 Lamps test	7 – 133
7.6 Communication	7 – 134
7.6.1 RS 232 interface	7 – 135
7.6.2 RS 485 interface	7 – 136
7.6.3 L2DP bus (Profibus)	7 – 137
7.6.4 SMS	7 – 138
7.6.5 Saving settings	7 – 138
7.7 Languages	7 – 139
7.7.1 Setting the language	7 – 139

1 Technical specification

1.1 Power Supply

Power supply for SIGMA CONTROL

Rated voltage 24 V DC (stabilized)

Consumption 1.3 A (standard controller)

Consumption 2.5 A (with expander board)

Auxiliary voltage for sensors (from the controller)

Voltage 18 V DC

Note	All voltages are generated within the compressor package itself
-------------	--

1.2 Sensors

Pressure transducer:

Output signal 4 – 20 mA

Connection two wire

Resistance thermometer

Sensing resistance PT100 to DIN IEC 751

Connection two wire

1.3 Hardware

- industrial computer with Intel® processor
- analog inputs and outputs (0–20 mA, 4–20 mA and PT100)
- 230/115 V relay outputs (voltage-free contacts)
- electronic 24 V outputs (common negative rail, short circuit and overload proof)
- 24 V common negative rail digital inputs
- internal undervoltage monitoring of 24 V supply
- internal temperature monitoring
- 3 serial interfaces:
 - RS 232 (modem)
 - RS 485 (master–slave control)
 - Profibus DP
- buffered real–time clock
- buffer battery for RAM and real–time clock
- permissible operating temperature range: –4 °F ... + 140 °F

1.3.1 Interface pin connections

1.3.1.1 RS 232

- Connections

<i>Pin 1</i>	<i>spare</i>
<i>Pin 2</i>	<i>receive data RxD</i>
<i>Pin 3</i>	<i>receive data RxD</i>
<i>Pin 4</i>	<i>reserved</i>
<i>Pin 5</i>	<i>ground</i>
<i>Pin 6</i>	<i>spare</i>
<i>Pin 7</i>	<i>request to send RTS</i>
<i>Pin 8</i>	<i>clear to send CTS</i>
<i>Pin 9</i>	<i>spare</i>

Connect shielding to both plug housings

1.3.1.2 RS 485

- Connections

<i>Pin 1</i>	<i>terminating resistor RA</i>	<i>(integrated in SIGMA CONTROL)</i>
<i>Pin 2</i>	<i>reserved</i>	
<i>Pin 3</i>	<i>difference signal B</i>	
<i>Pin 4</i>	<i>reserved</i>	
<i>Pin 5</i>	<i>reserved</i>	
<i>Pin 6</i>	<i>reserved</i>	
<i>Pin 7</i>	<i>terminating resistor RB</i>	<i>(integrated in SIGMA CONTROL)</i>
<i>Pin 8</i>	<i>difference signal A</i>	
<i>Pin 9</i>	<i>reserved</i>	

Connect shielding to both plug housings

1.3.1.3 Profibus

- Connections

<i>Pin 1</i>	<i>spare</i>
<i>Pin 2</i>	<i>spare</i>
<i>Pin 3</i>	<i>Profibus connection B</i>
<i>Pin 4</i>	<i>TTL signal RTS</i>
<i>Pin 5</i>	<i>ground</i>
<i>Pin 6</i>	<i>+ 5V for interface P5</i>
<i>Pin 7</i>	<i>spare</i>
<i>Pin 8</i>	<i>Profibus connection A</i>
<i>Pin 9</i>	<i>spare</i>

Connect shielding to both plug housings

1.4 Software

- real-time operating system
- soft PLC
- visualization software
- user software

2 Safety Regulations

2.1 Explanation of Symbols and Instructions



This symbol is placed before all instructions regarding safety where danger to life and limb can occur during work. It is very important that these instructions are observed and that extreme care is taken. For their own protection, all other users should be informed of these safety instructions. The general safety and accident prevention regulations must be observed as well as the safety instructions laid down in this service manual.

Attention!

This symbol is placed at text to which considerable attention must be paid to ensure that recommendations, instructions, references and the correct sequence of work are complied with and that damage to or destruction of the controller or other equipment is prevented.

Note

This symbol identifies important product information, handling of the product or the corresponding section of the documentation to which special attention must be paid.



This symbol identifies operations and actions to be carried out by the operator or service technician.

- This bullet identifies listings.

Explanation of warning labels:



Beware of hot surface. Do not touch surface; danger of burning.



Beware of high voltage. Do not touch electrical components; danger of electric shock.



Beware! Machine starts automatically. Machine can start automatically or by remote start command.



Beware of rotating parts. Do not touch rotating parts as this can cause pinching/injury.

2.2 General Instructions



Before work is carried out on electrical equipment carry out the following measures in the order shown:

1. Switch off the main switch
2. Lock out the main switch
3. Check that no voltage is present on the equipment

Attention!

Any alterations or reconstruction carried out without consultation with and the previous consent of KAESER COMPRESSORS will invalidate the warranty.

Attention!

Safety devices may not be modified or deactivated.

Signs and labels of reference may not be removed or rendered unreadable.

2.3 Safety Regulations for the Controller

- Do not pull out or push in components (plugs) on the controller when the compressor package is running. This can cause damage to the controller.
- Do not run the compressor package with supplies removed from the controller as irreversible damage could occur (e.g. feed to the digital outputs with no power supply connected).
- Do not apply other voltages to the electronic outputs on the output plug pins (i.e. external feed via wire jumpers, etc.).
- A short circuit at the power supply pins of the Profibus interface can cause irreversible damage to the interface.

3 General

3.1 Short Description

The electronic controller SIGMA CONTROL comprises an industrial computer with an Intel® processor, a user interface with a background illuminated plain text display, keys, some with integrated LEDs and digital and analog inputs and outputs. Power to the controller is provided by a stabilised 24 V DC power supply unit.

The controller is provided with a clear, easily understood user interface that allows call-up of information or entry of settings:

- LEDs indicate the most important operational states.
- various functions can be keyed.
- the plain text display provides the user with information on current events in the selected language
- an event information memory records the last 100 events with date and time, e.g. alarm, service and operational messages.

SIGMA CONTROL controls, regulates, protects and monitors the compressor package.

The control function provides:

- automatic changeover from load to idle or standstill ensuring optimum utilisation of the drive motor according to the user's actual air demand.
- automatic start after a power supply failure.

SIGMA CONTROL's protective function ensures:

- automatic shutdown of the compressor package if overcurrent, overpressure, overtemperature, etc. occurs, that is, if a fault occurs that can cause damage to the compressor package.

SIGMA CONTROL's monitoring function ensures:

- punctual maintenance prompts for oil filter, air filter, V-belts, motor bearings, electrical components and other internal components. All these functions are monitored by service hour counters and maintenance due is displayed as warning or service messages in the plain text display.

All important data can be transferred via the Profibus using integrated interface software.

All parameters needed to operate KAESER rotary screw compressors and vacuum packages are contained in SIGMA CONTROL. They are set up at the factory according to compressor model. These parameters can be displayed or changed with the help of various menus or sub-menus in the software (see also chapter 5).

Parameter settings and changes are entered in the Display and Setup level of the software after input of a password. The type of drive, pressure control mode (DUAL, QUADRO or VARIO), the model and basic model status, for example, can be entered at this level.

3.2 Finding the best Type of Pressure Regulation

SIGMA CONTROL is provided with various types of regulation. This means that the compressor package can be operated at maximum efficiency depending on the user's air demand.

- ☞ select the type of regulation in the 'configuration' menu.
- ☞ reset the 'duty cycle from' parameter in the 'statistic' menu.
- ☞ Run the compressor package for a longer period of time (at least four weeks, or more).
- ☞ Evaluate the 'duty cycle from' parameter.

Repeat this procedure for all types of pressure regulation.

	DUAL control	QUADRO control	VARIO control
duty cycle (%)			

Note

The type of pressure regulation with maximum duty cycle is the most efficient.

3.3 DUAL Control

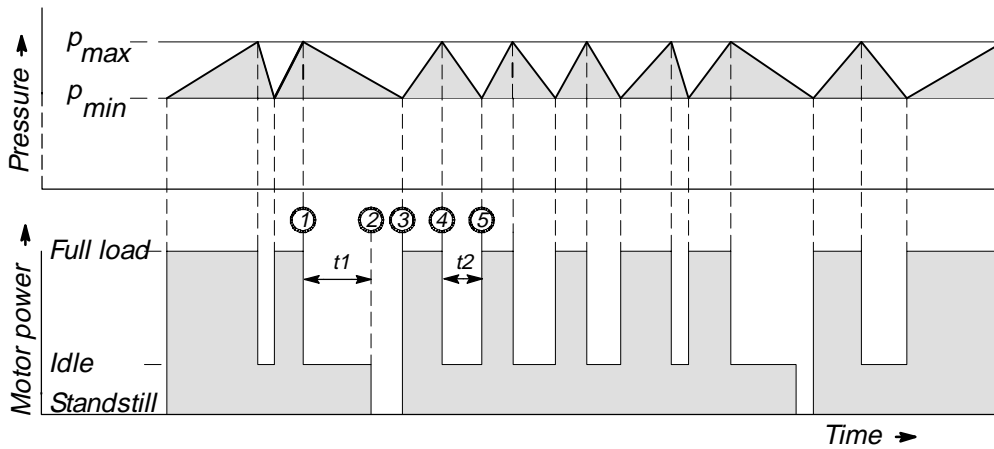

In DUAL control mode (combined idle and start–stop) the compressor normally runs in **load** and **idle** or **standstill**.

The controller regulates the compressor package between **load** and **idle**.

If the compressor package runs in idle for longer than the preset period (1) to (2), for example $t_1 = 6$ minutes in idle, the drive motor is stopped completely (2). When the lower switching point p_{min} (3) is reached, the compressor package is automatically started again. Pressure rises to the upper switching point p_{max} (4), and the compressor package switches to idle. If the pressure falls again to p_{min} (5) within a shorter period (4) to (5), for example, $t_2 = 3$ min, then the compressor switches automatically from idle to load.

3.4 QUADRO Control

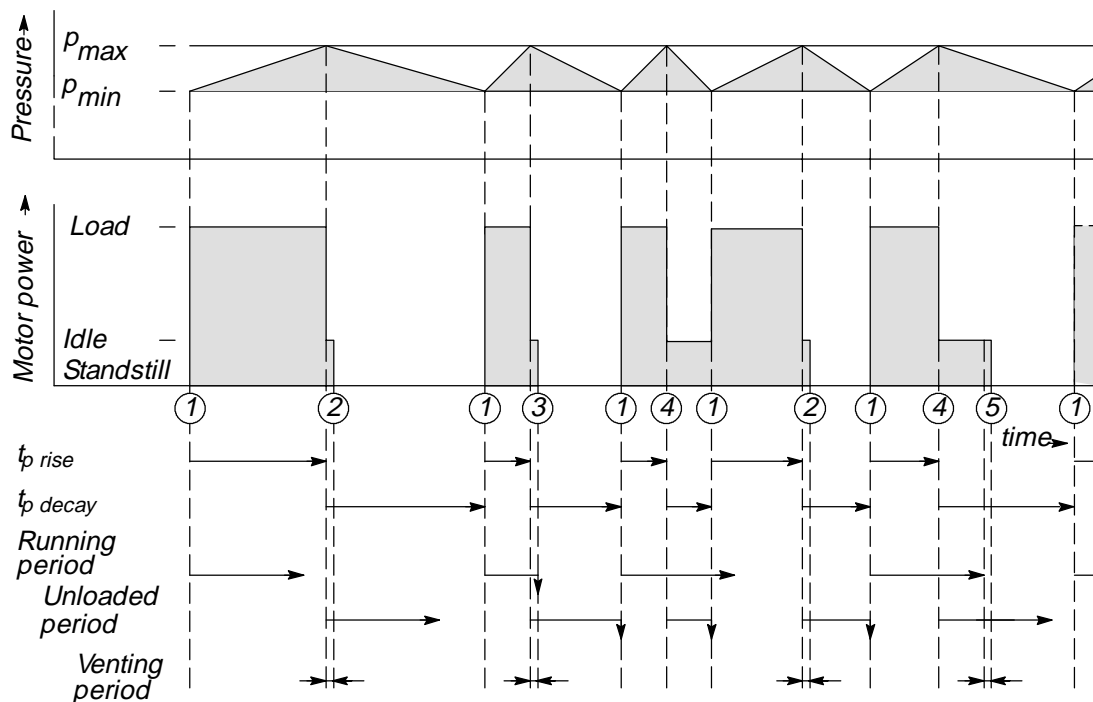

↘ stop point for running or idle / standstill period

p_{max} upper switching point

p_{min} lower switching point

$t_{p rise}$ pressure rise time (the time during which system pressure rises from the lower to the upper switching point)

$t_{p decay}$ pressure decay time (the time during which system pressure decays from the upper to the lower switching point)

Function description

Two fixed periods – the **running period** and **unloaded period** – are taken as the criterion for selection of the operating mode of the compressor package when system pressure reaches the upper switching point. These two periods are set according to the maximum permissible starting frequency of the drive motor.

The running period starts every time the compressor package is switched on. It lasts as long as the drive motor runs and stops when the compressor package switches to standstill.

The unloaded period starts every time the operating mode changes from load to idle. It runs during idle and also when the compressor package is switched to standstill after the idle period. It stops when the compressor package switches to load.

Every cut–out point is delayed by the venting period, so that the compressor package vents.

The following switching cycles are possible:

- If system pressure decays to the lower switching point, the compressor package switches to load (1) irrespective of its previous operating mode. If the drive motor was at standstill, the opening of the inlet valve is delayed to allow an unloaded compressor package start.
- If system pressure rises to the upper switching point and the running period has already expired, the compressor package switches off after the run–on period has expired (2).

- If system pressure rises to the upper switching point before the running period has expired, the pressure decay time of the previous switching cycle is taken as the criterion for the selection of the operating mode:
 - If the pressure decay time t_{pdecay} was longer than the idle/standstill period, the compressor package switches to standstill after the run–on period has expired **(3)**.
 - If the pressure decay time t_{pdecay} was shorter than the period set for the idle / standstill period, then idle mode is selected **(4)**, that is, the inlet valve closes and the compressor package is vented with the motor running. When the running period expires the compressor package is also switched to standstill after the run–on period has expired **(5)**.

3.5 VARIO Control

Functional description:

The idle period is automatically lengthened or shortened by the variable idle control in relation to the number of motor starts. The number of motor starts during the preceding hour are measured.

A high switching frequency leads to longer idle periods.

A low switching frequency leads to shorter idle periods.

4 Operation

4.1 Control Panel



- 1 SIGMA controller
- 2 Emergency Stop pushbutton

4.2 The SIGMA CONTROL System

The SIGMA CONTROL unit (1) is fitted in the control cabinet. It is used for both control and operation. The panel has 11 keys and 9 LEDs. The operation of the package is determined by default values programmed in the controller.

4.3 EMERGENCY STOP Pushbutton

The EMERGENCY STOP button shuts down the compressor package immediately.

If the EMERGENCY STOP button is pressed because of an existing hazard or alarm, then this must be eliminated before the package is reset. To accomplish this, carry out the following procedure:





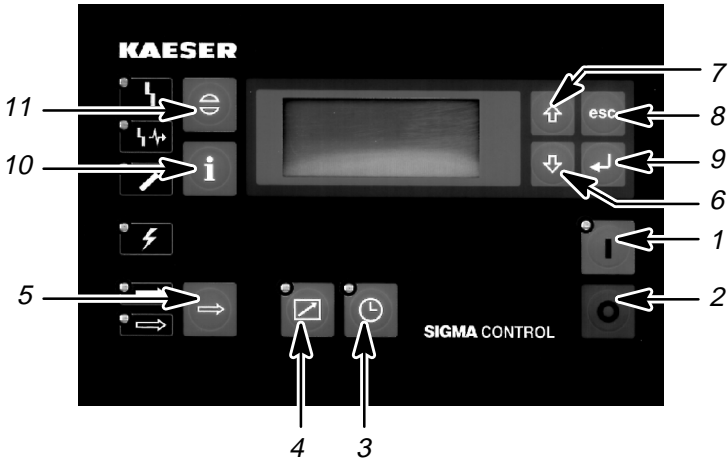





- ☞ Turn the EMERGENCY STOP button in the direction of the arrow to unlatch it.
- ☞ Press the acknowledge (reset) key on SIGMA CONTROL to acknowledge the alarm. (See chapter 4.3.1 for function keys).

4.3.1 Function keys



- | | |
|------------------------------|---------------------------|
| 1 ON key ("I") | 7 Arrow key (↑) (menu up) |
| 2 OFF key ("O") | 8 Escape key |
| 3 Clock key | 9 Return key (↵) |
| 4 Remote key | 10 Info - event key |
| 5 Load/unload changeover key | 11 Reset key |
| 6 Arrow key (↓) (menu down) | |

4.3.2 Key functions

Symbol	Item	Description	Function
	1	ON key	The compressor is switched on and runs in the preselected operating mode: local control – remote control (control centre) – clock control
	2	OFF key ("0")	The compressor is switched off irrespective of operating mode.
	3	Clock ON/OFF key	Pressing the key causes the compressor to be switched on and off by the integrated clock. The LED illuminates in clock mode.
	4	Remote ON key	Pressing the key switches between local and remote control of the compressor package. The LED illuminates in remote mode.
	5	Load/idle change-over key	Pressing the key switches the compressor into idle mode. Pressing again switches back to the preselected mode.
	6	Arrow key ↓	Menus are scrolled downwards or a selected parameter is reduced.
	7	Arrow key ↑	Menus are scrolled upwards or a selected parameter is increased.
	8	Escape key	Pressing the "esc" key: – returns to the next higher menu level – exits the edit mode without saving edited parameters If the "esc" key is held down longer than 10 s a return to the main menu is triggered.
	9	Return key (save)	Only affects the message in the third line of the display (12): – returns to the selected submenu or – exits edit mode and saves edited parameters
	10	Info – event key	Display of the event information memory: can be selected in any menu. The display jumps back to the last menu position with the "esc" key (8).
	11	Acknowledge (reset) key	Acknowledges alarm messages and resets the alarm memory (if permitted).

4.3.3 Light emitting diodes and plain text display

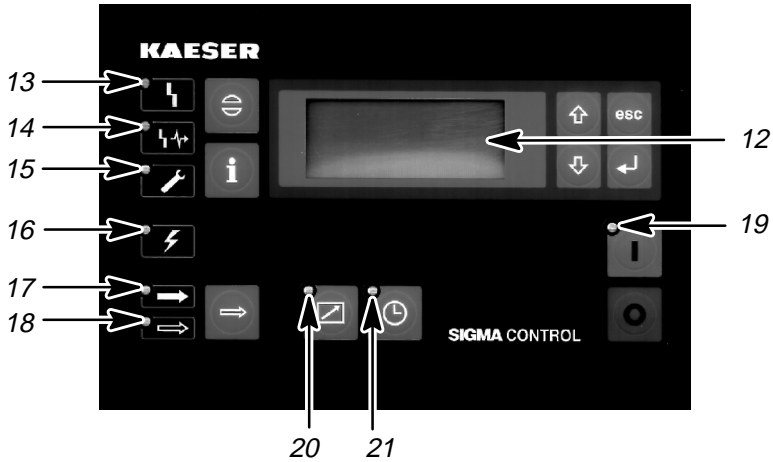

- | | |
|---------------------------------|----------------------|
| 12 Four-line display | 17 Load LED |
| 13 Alarm LED | 18 Idle LED |
| 14 Communication alarm LED | 19 Compressor ON LED |
| 15 Warning – maintenance LED | 20 Remote ON LED |
| 16 Power ON LED (to controller) | 21 Timer ON LED |

4.3.4 LED functions

Symbol	Item.	Description	Function
	12	Display see 4.3.3	Alphanumeric display with 4 lines and green background illumination
	13	Alarm LED	The red LED flashes if the compressor package is shut down because of an alarm. If the alarm is acknowledged with the reset key (11), the LED lights continuously. It extinguishes when the fault is removed and the alarm is reset again.
	14	Communication alarm LED	The red LED illuminates if communication via the Profibus interface is interrupted. If the communication fault occurs in remote mode, the compressor package is automatically switched to local control. When the reset key (11) is pressed, the LED extinguishes if the alarm is no longer present.
	15	Service/warning LED	The yellow LED flashes if there is a service message or when maintenance is due. If the message is acknowledged with the reset key (11), the LED illuminates continuously until maintenance is completed and (if necessary) the service interval counter is reset. (see chapter 6.4.1 to reset the service interval counter)
	16	Power ON LED	The green LED lights when power is available. (The main switch and the control transformer cutout are switched on)
	17	Idle LED	The green LED illuminates continuously when the compressor is running but no compressed air is produced. The LED flashes if idle mode is selected with the idle key (5).
	18	Load LED	The green LED illuminates when the compressor is running under load and compressed air is being produced.
	19	Package on LED	The compressor package is switched on. LEDs 17 and 18 must also be taken into consideration to determine the operational status of the package: If LED (19) is on – and both LEDs (17) and (18) are off, the package is stopped and in standby. It can start at any moment.
	20	Remote control mode	The green LED illuminates when the package is in remote control mode.
	21	Clock mode ON LED	The green LED illuminates when the package is switched either on or off by the clock.

4.3.4.1 Display

The display (12) used for entry and readout of data and is provided with four lines of 16 characters each.

Example:

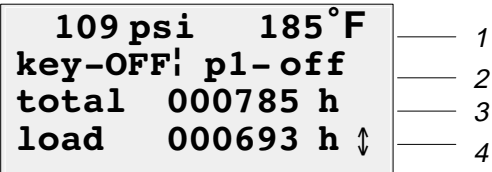
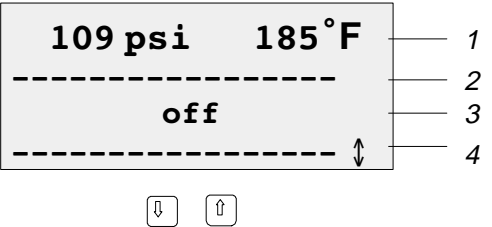

- | | | | |
|---|-----------------------------|---|-------------|
| 1 | Header | 3 | Active line |
| 2 | Compressor status/menu text | 4 | Menu text |

Line 1 – header

Current system pressure and airend discharge temperature are displayed in the header.

These values are always shown

- in the main menu
- in setup levels in which parameter changes can be made even though the compressor is running.

The letters “R”, “S” and “F” identify internal operational modes of the controller and are shown for servicing purposes.

“R” means that the controller is in “RUN mode’ and is working perfectly.

“S” means that the controller has been set to “Stop” by a programming unit (PG).

“F” means that there is a program fault.

Note If an “S” or an “F” appears in the display, switch the power off and then back on again to return to the “R” status. If this is unsuccessful, contact KAESER service department for further instructions.

Line 2

Depending on settings, either the current status of the compressor package or menu text is shown in line 2.

Line 3 – active line**Note**

Actions can only be executed if they are shown in in line 3.

This applies both a jump to to submenus or the changing of values.

The respective menu text is shown here.

Example:

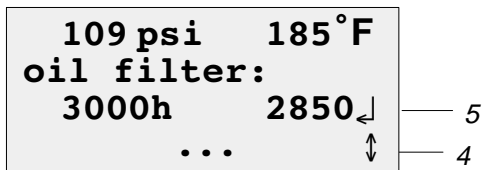

5 Entry line with “Return (↵)”

If it is possible to move to a submenu or if a parameter can be entered the “Return (↵)” sign (5) appears in column 16.

Line 4

The arrows “↑”, “↓” or “↕” (4) appear in line 4, column 16 after the menu text and indicate the direction in which the lines can be scrolled:

- ↑ – lower stop, upwards scroll only
- ↓ – upper stop, downwards scroll only
- ↕ – scroll in both directions

4.4 Switching the Compressor Package On and Off

Attention!

Do not switch the compressor package on and off with the main switch. Always switch on with the ON key (1) and off with the OFF key (2). Always take the permissible motor starting frequency into account when switching the compressor package on and off.

4.4.1 Switching on locally

☞ Switch on the main switch.

The controller runs a selftest. When the selftest is completed the green "power ON LED (16) illuminates permanently.

☞ Press the ON key (1) – the green "compressor ON" LED (19) illuminates.

LEDs 17 and 18 must be taken into consideration to determine the operational status of the compressor package:



If LED (19) is on – and both LEDs (17) and (18) are off, the package is stopped and in standby.

The compressor can start at any moment.

4.4.2 Switching off locally

☞ Press the OFF key (2) – the "Package ON" LED (19) extinguishes.

☞ Switch off and lock out the main switch.

4.4.3 Switching on and off in remote

Remote control of the compressor package is selected with the "Remote ON" key (4) on the controller.

Choice of control via volt-free remote contacts "RC" on a binary input can be made in the "configuration→compressor start→compressor ON" menu.

4.4.4 Switching on and off with the clock

If required, the compressor package can be controlled by the clock. The procedure is the same as for switching on and off locally except that the "Clock mode ON/OFF-key" (3) must be pressed additionally.

Afterwards, the periods during which the compressor is to run can be entered in the "clock-compressor ON/OFF" menu.

See chapter 7.2 for setting up the clock.



Before carrying out any work, make sure that the package cannot be switched on by the clock or from the control center.

4.5 Resetting Alarm Messages

If an alarm occurs, the compressor package is shut down automatically and the red LED (13) on SIGMA CONTROL flashes.

The bottom line of the display (12) shows the current alarm.

A list of possible alarms (faults) that could occur during operation of the compressor package is given in chapter 4.7.

- ☞ Remove the fault.
- ☞ Reset the alarm with the reset key (11) – LED (13) extinguishes.

The compressor package can now be started again.

Attention!

If the compressor was shut down with the EMERGENCY STOP pushbutton, ensure that the pushbutton is enabled by turning in the direction of the arrow before resetting the alarm.

4.6 Acknowledgement of Warning Messages

When maintenance is due the yellow LED (15) on SIGMA CONTROL flashes.

Maintenance due is shown in the display (12). A list of service messages that can be displayed during operation is given in chapter 4.7).

- ☞ Carry out the maintenance.
- ☞ Acknowledge service message with the reset key (11) – LED (15) extinguishes.

Note

When the maintenance is complete the remaining interval must be reset to the default service interval.

- ☞ (see chapter 6.4.1 to reset the service interval counter).

Note

Password level 4 is required to reset the service interval counter.

- ☞ See chapter 7.1.1 to input the password.

4.7 Alarm and Warning Messages

Message ²	Type ¹	Fault	Remedy
access doors	W	Access doors opened with the compressor package stopped	Close the doors.
access doors	A	Access doors opened with the compressor package running	Close the doors.
ADT ↑	W	The maximum airend discharge temperature (ADT) will soon be reached	Ensure sufficient ventilation, keep the ambient temperature below + 105° F, clean the cooler, cooling air outlet too near a wall, check oil level, renew the oil filter.
ADT ↑↓	A	The maximum airend discharge temperature (ADT) exceeded	Ensure sufficient ventilation, keep the ambient temperature below + 105° F, clean cooler, cooling air outlet too near a wall, check oil level, renew the oil filter.
ADT dT/dt	A	Airend discharge temperature (ADT) rise rate exceeded	Check airend and piping to airend ³ , top up the oil, check oil circulation.
Al 1 open cct	A	The connection between analog input 1 and the system pressure transducer is open circuit or there is a short to earth	check pressure transducer, line and connection, have the defective transducer changed ³
Al 2 open cct	A	The connection between analog input 2 and the pressure transducer for internal pressure is open circuit or there is a short to earth	check pressure transducer, line and connection, have the defective transducer changed ³
Al 3 open cct	A	The connection between analog input 3 and the resistance thermometer for measuring airend discharge temperature is open circuit	check sensor, line and connection, have the defective sensor changed ³
Al 4 open cct	A	The connection between analog input 4 and the resistance thermometer for measuring drive motor temperature is open circuit	check sensor, line and connection, have the defective sensor changed ³
Al 5 open cct	A	The connection between analog input 5 and a sensor is open circuit or there is a short to earth	check sensor, line and connection, have the defective sensor changed ³
Al 6 open cct	A	The connection between analog input 6 and a sensor is open circuit or there is a short to earth	check sensor, line and connection, have the defective sensor changed ³

¹ A⇒ alarm W⇒ warning

² Symbols: high:↑ / too high:↑↑ / low:↓ / too low:↓↓

³ Contact authorised KAESER service agent

Message ²	Type ¹	Fault	Remedy
Al 7 open cct	A	The connection between analog input 7 and a sensor is open circuit	check sensor, line and connection, have the defective sensor changed ³
Al 8 open cct	A	The connection between analog input 8 and a sensor is open circuit	check sensor, line and connection, have the defective sensor changed ³
airend rotation	A	The motor is turning in the wrong direction	Change phases: swap L1 and L2 power connections
air filter dp ↑	W	The pressure drop across the air filter is too high The air filter is clogged	Clean/replace the air filter element
air filter h ↑	W	The default service interval for checking the air filter has expired	Clean the air filter element see chapter 6.4.1 to reset the service interval counter
back pressure	A	There is still back pressure in the oil separator tank because of poor venting (V–belt drive compressors only)	Check the venting line and the venting valve, check the MPCV
back pressure?	A	There is still back pressure in the oil separator tank because of poor venting (direct drive compressors only)	Check the venting line and the venting valve, check the MPCV
bearings h ↑	W	The default service interval for the greasing the motor bearings has expired	Grease the motor bearings (see chapter 6.4.1 to reset the service interval counter)
blowoff prot.	W	Warning: The response pressure of the pressure relief valve will soon be exceeded	Change the oil separator element, check the minimum pressure/check valve (MPCV), control valve, inlet valve, have defective valve changed ³ , open the shut–off valve in the venting line, check the pressure transducer, have the defective transducer changed ³
blowoff prot.	A	The response pressure of the pressure relief valve on the oil separator tank is exceeded	Change the oil separator element, check the minimum pressure/check valve (MPCV), control valve, inlet valve, have defective valve changed ³ , open the shut–off valve in the venting line, check pressure transducer, line and connection, have the defective transducer changed ³
buffer battery	W	The battery in the controller is discharged	Contact KAESER service ³
condensatedrain	W	Warning: Condensate drain faulty	Check condensate drainage (clean, repair)

¹ A⇒ alarm

W⇒ warning

² Symbols: high:↑ / too high:↑ / low:↓ / too low:↓

³ Contact authorised KAESER service agent

Message ²	Type ¹	Fault	Remedy
condensatedrain	A	Condensate drain faulty	Check condensate drainage (clean, repair)
coolingwater low	A	Cooling water pressure too low	Check cooling water throttling valve, No inlet water pressure, Shut-off valve missing
elect. equip. h ↑	W	The default service hours for checking electrical equipment and wiring have expired	Have electrical equipment checked by a trained electrician, see chapter 6.4.1 to reset the service interval counter 6.4.1
emergency stop	A	The emergency stop button was pressed	Unlatch the pushbutton
ext.load signal?	W	External load signal indistinct: The default cut-out pressure high has been exceeded	The external load control has not switched to idle, even though the maximum permissible system pressure has been exceeded Check settings of the external controller Take the pressure drops across filters and dryer into account Have the deviations between the pressure transducers checked ³ .
ext. message 0	W	Message text freely definable with SIGMA CONTROL	Remove fault
ext. message 0	A	Message text freely definable with SIGMA CONTROL	Remove fault
ext. message 1	W	Message text freely definable with SIGMA CONTROL	Remove fault
ext. message 1	A	Message text freely definable with SIGMA CONTROL	Remove fault
ext. message 2	W	Message text freely definable with SIGMA CONTROL	Remove fault
ext. message 2	A	Message text freely definable with SIGMA CONTROL	Remove fault
ext. message 3	W	Message text freely definable with SIGMA CONTROL	Remove fault
ext. message 3	A	Message text freely definable with SIGMA CONTROL	Remove fault
ext. message 4	W	Message text freely definable with SIGMA CONTROL	Remove fault
ext. message 4	A	Message text freely definable with SIGMA CONTROL	Remove fault
ext. message 5	W	Message text freely definable with SIGMA CONTROL	Remove fault
ext. message 5	A	Message text freely definable with SIGMA CONTROL	Remove fault

¹ A⇒ alarm

W⇒ warning

² Symbols: high:↑ / too high:⬆ / low:↓ / too low:⬇

³ Contact authorised KAESER service agent

Message ²	Type ¹	Fault	Remedy
ext. message 6	W	Message text freely definable with SIGMA CONTROL	Remove fault
ext. message 6	A	Message text freely definable with SIGMA CONTROL	Remove fault
ext. message 7	W	Message text freely definable with SIGMA CONTROL	Remove fault
ext. message 7	A	Message text freely definable with SIGMA CONTROL	Remove fault
fan M2 I ↑	A	First fan motor shut down because of overload	Investigate cause, then reset the motor overload trip
fan M3 I ↑	A	Second fan motor shut down because of overload	Investigate cause, then reset the motor overload trip
fan M4 I ↑	A	Third fan motor shut down because of overload	Investigate cause, then reset the motor overload trip
flash memory	W	Internal controller memory error	Have the controller replaced ³
HT cell	A	Fault in the high tension cell	Have the high tension cell checked ³
L2DP-controller	A	The bus link from the Profibus DP interface is interrupted	Check the bus link and plug, check interface configuration (see chapter 7.6.3), Have the controller replaced ³
L2DP-timeout	W	L2DP bus fault	Check the bus link and plug, check interface configuration (see chapter 7.6.3), Have the controller replaced ³
mains cont. on?	A	The mains contactor does not pull in despite an ON command	The answerback on input 0.6 (24V) does not appear after compressor start, check auxiliary contact block on K1M, Check 230 V supply to the contactor (door interlock switch, EMERGENCY STOP)
mains cont. off?	A	The mains contactor does not drop out despite an OFF command	The answerback from mains contactor K1M (0.6) is still present, even though the compressor is at standstill
mains monitor	A	Fault in mains power supply	an optional voltage monitor reported a fault, possible drop in voltage

¹ A⇒ alarm

W⇒ warning

² Symbols: high:↑ / too high:↑↑ / low:↓ / too low:↓↓

³ Contact authorised KAESER service agent

Message ²	Type ¹	Fault	Remedy
mains voltage ↓	W	1st power supply failure: The compressor will be restarted automatically	Contactors K1M fluttered during drive motor run, check power supply, possible intermittent contact in a door interlock switch
mains voltage ↓	A	2nd power supply failure: The drive motor is shut down	Contactors K1M fluttered during drive motor run, check power supply, possible intermittent contact in a door interlock switch
model	A	Model indistinct	Enter model again (level 5 required), If message appears repeatedly change the controller
modem problem	W	SIGMA CONTROL does not recognise the modem	Check the link between SIGMA CONTROL and the modem
motor bearings	A	Overheating of motor shaft ball bearings	Grease the motor bearings with the greasing device, bearing damage, have the bearings replaced ³
motor bearings h	W	The default service interval for replacement of the motor shaft bearings has expired	Have maintenance carried out ³ , Have the motor bearings replaced ³
motor I ↑	A	Drive motor shutdown because of overload	Investigate cause, then reset overload trip
motor T ↑	W	Drive motor very hot	Ensure sufficient ventilation Fit cooling air discharge fan, motor dirty, clean motor
motor T ↑	A	Drive motor too hot (temperature sensed by PTC sensor and trip)	Ensure sufficient ventilation Fit cooling air discharge fan, motor dirty, clean motor
motorstarts /h↑	W	The maximum permissible motor starting frequency was exceeded during the last 60 min	Lengthen idle period Increase capacity of air receiver, increase cross-section of piping between compressor package and air receiver, check the pressure transducer, have defective sensor changed ³

¹ A⇒ alarm

W⇒ warning

² Symbols: high:↑ / too high:↑↑ / low:↓ / too low:↓↓

³ Contact authorised KAESER service agent

Message ²	Type ¹	Fault	Remedy
motorstarts /d ↑	W	The maximum permissible motor starting frequency per day was exceeded during the last 24 hours	Lengthen idle period Increase capacity of air receiver, increase cross-section of piping between compressor package and air receiver, check the pressure transducer, have defective sensor changed ³
no press. buildup	W	The package cannot build up pressure after a compressor start	Check the complete compressor package for faults (leaks, ...), check inlet valve, MPCV, compare indication of internal pressure in 'analog data' menu with the pressure gauge on the oil separator tank
no press. buildup	A	The package cannot build up pressure Package pressure does not rise above 50 psi(g) within a preset period	Check the complete compressor package for faults (leaks, ...), check inlet valve, MPCV, compare indication of internal pressure in 'analog data' menu with the pressure gauge on the oil separator tank
O 0.6/O 0.7	A	The connection between output 0.6 or 0.7 and a consumer load is short circuited.	Check consumer load, line and connections (e.g. solenoid valve), replace defective consumer load
O 1.6/O 1.7	A	The connection between output 1.6 or 1.7 and a consumer load is short circuited.	Check consumer load, line and connections (e.g. solenoid valve), replace defective consumer load
oil change h ↑	W	The default service interval for the oil change has expired	Carry out an oil change, (see chapter 6.4.1 to reset the service interval counter)
oil content ↑	W	Warning: The oil content for pure air will soon be reached	Check the scavenge tube in the oil separator element, check the dirt trap strainer in the scavenge line, check the oil separator element, check the oil sensor, line and connections ³
oil content ↑	W	The oil content for pure air will soon be exceeded	Check the scavenge tube in the oil separator element, check the dirt trap strainer in the scavenge line, check the oil separator element, check the oil sensor, line and connections ³
oil filter dp ↑	W	The oil filter is clogged	Change the oil filter
oil filter h ↑	W	The default service interval for checking the oil filter has expired	Carry out an oil filter change, (see chapter 6.4.1 to reset the service interval counter)

¹ A⇒ alarm

W⇒ warning

² Symbols: high:↑ / too high:↑ / low:↓ / too low:↓

³ Contact authorised KAESER service agent

Message ²	Type ¹	Fault	Remedy
oil level ↓	W	Oil level too low	Top up the oil
oil p ↓	A	No changeover to load as long as the minimum oil pressure is not reached	Check oil circulation, check pressure switch, line and connections, have the defective switch changed ³
oil T ↓	W	No changeover to load as long as the minimum oil temperature is not reached	check oil circulation, Check temperature switch, line and connections, have the defective switch changed ³
PD temperature ↓	W	Warning: package discharge temperature too low	Two-speed cooling fan running at high speed only – switch to lower speed
PD temperature ↓	A	Package discharge temperature too low	Two-speed cooling fan running at high speed only – switch to lower speed, check fan motor, check sensor, regulator, check inverter, clean cooler, top up the oil
PD temperature ↓	W	Warning: package discharge temperature too high	Two-speed cooling fan running at low speed only – switch to higher speed, check fan motor, clean cooler, top up the oil
PD temperature ↑	A	Package discharge temperature too high	Two-speed cooling fan running at low speed only – switch to higher speed, check fan motor, have sensor, regulator tested ³ , have frequency inverter tested ³ , clean cooler, top up the oil
RAM	W	Internal RAM defective	Check the controller, have the controller replaced ³
RD compr. p ↑	A	Pressure switch on the refrigerant compressor activated (packages with refrigeration dryer only)	Ensure sufficient ventilation fit cooling air discharge fan, clean the refrigerant condenser

¹ A⇒ alarm

W⇒ warning

² Symbols: high:↑ / too high:↑ / low:↓ / too low:↓

³ Contact authorised KAESER service agent

Message ²	Type ¹	Fault	Remedy
RS485err:chksum	W	Wrong configuration or transmission error	Check the link/interface connections between the two controllers, check maximum cable length and screening, check all interface parameters, i.e. both subscribers active, 1 master and 1 slave configured, bi-rate and character frame (format) for both subscribers identical (see also chapter 4.8.6.1).
RS485err:dial up	W	Wrong configuration or transmission error	Check the link/interface connections between the two controllers, check maximum cable length and screening, check all interface parameters, i.e. both subscribers active, 1 master and 1 slave configured, bi-rate and character frame (format) for both subscribers identical (see also chapter 4.8.6.1).
RS485err:initdrv	W	Wrong configuration or transmission error	Check the link/interface connections between the two controllers, check maximum cable length and screening, check all interface parameters, i.e., both subscribers active, 1 master and 1 slave configured, bi-rate and character frame (format) for both subscribers identical (see also chapter 4.8.6.1).
RS485err:protoc.	W	Wrong configuration or transmission error	Check the link/interface connections between the two controllers. Check maximum cable length and screening, check all interface parameters, i.e. both subscribers active, 1 master and 1 slave configured, bi-rate and character frame (format) for both subscribers identical (see also chapter 4.8.6.1).

¹ A⇒ alarm

W⇒ warning

² Symbols: high:↑ / too high:↕ / low:↓ / too low:⇓

³ Contact authorised KAESER service agent

Message ²	Type ¹	Fault	Remedy
RS485err:transm.	W	Wrong configuration or transmission error	Check the link/interface connections between the two controllers, Check maximum cable length and screening, check all interface parameters, i.e., both subscribers active, 1 master and 1 slave configured, bitrate and character frame (format) for both subscribers identical (see also chapter 4.8.6.1).
separator dp ↑	W	The oil separator is clogged	Change the oil separator element
separator h ↑↓	W	The default service interval for checking the oil separator has expired	Change the oil separator element (see chapter 6.4.1 to reset the service interval counter)
separator T ↑	A	Air temperature at oil separator discharge exceeded	Have the trip device at the oil separator air discharge checked ³ , check the sensor and line to the trip device, replace defective trip device
set output!		The "set output" test function is activated	End the "set output" mode.
sh.cct AI1	A	Short circuit at analog input 1	Check line and connections, check the transducer that is measuring system pressure
sh.cct AI2	A	Short circuit at analog input 2	Check line and connections, check the transducer that is measuring internal pressure
sh.cct AI3	A	The connection between analog input 3 and the resistance thermometer for measuring airtend discharge temperature is either short circuit or shorted to earth	check sensor, line and connection, have the defective PT 100 sensor for ADT changed ³
sh.cct AI4	A	The line between analog input 4 and a sensor is short circuit or is shorted to earth	check sensor, line and connection, have the defective sensor changed ³
sh.cct AI5	A	Short circuit at analog input 5	Check line and connections
sh.cct AI6	A	Short circuit at analog input 6	check sensor, line and connection,
sh.cct AI7	A	The line between analog input 7 and a sensor is short circuit or is shorted to earth	check sensor, line and connection, have the defective sensor changed ³
sh.cct AI8	A	The connection between analog input 8 and the resistance thermometer for measuring drive motor temperature is either short circuit or shorted to earth	check sensor, line and connection, have the defective sensor changed ³

¹ A⇒ alarm

W⇒ warning

² Symbols: high:↑ / too high:↑↑ / low:↓ / too low:↓↓

³ Contact authorised KAESER service agent

Message ²	Type ¹	Fault	Remedy
SIGMA CONTROL ↑↑T	A	The temperature in SIGMA CONTROL's housing has exceeded + 158° F	Ensure sufficient ventilation, keep ambient temperature below + 105° F.
softstart	A	Fault in the soft start system	Have the soft start system checked ³
start T ↑	A	The airtend discharge air temperature (ADT) is too low to allow the package to be started (resistance thermometer temperature measurement)	The ambient temperature must be higher than + 5° F, have an auxiliary heating system fitted ³
system press. ↓	W	The system pressure has fallen below the "syspress. low" value because of leaks, pipe fracture, etc.	Air consumption too high, check air consumers, check pressure transducer, line and connection, check the "syspress. low" setting in the Configuration/Pressure settings menu, have the defective transducer changed ³
system press. ↓ (vacuum packages only)	W	The system pressure has fallen below the "syspress. high" value because of leaks, pipe fracture, etc.	Check vacuum package for leaks, check the "syspress. high" setting in the Configuration/Pressure settings menu, check whether the package switches to full load (inlet valve)
V-belts broken	A	The V-belts parted during machine operation	Fit new set of V-belts
V-belt tens. h ↑	W	The default service interval for checking V-belt tension has expired	Tension the V-belts, change the belts if necessary, (see chapter 6.4.1 to reset the service interval counter)
V-belt tension	W	The V-belt tension is too low	Tension the V-belts
VFD	A	The variable frequency drive system for the drive motor is defective	see service manual for the drive system
VFD mains	W	Failure of power supply to compressor variable frequency drive system	Check power supply (electrician)

¹ A⇒ alarm

W⇒ warning

² Symbols: high:↑ / too high:↑↑ / low:↓ / too low:↓↓

³ Contact authorised KAESER service agent

4.8 Frequently Programmed Functions

In this chapter, information on frequently programmed functions is given with the help of flow diagrams and examples.

- Initial Startup
- Initial startup in clock mode
- Correcting the package pressure
- Carrying out maintenance
- Base load changeover with MIC 4000
- Base load changeover with MVS 8000
- Base load changeover with VESIS
- Base load changeover between two compressor packages with SIGMA CONTROL
- Base load changeover with a compressor package controlled by a pressure switch

4.8.1 Procedure for initial startup (Standard Mode)

When the power supply to the controller is switched on the computer starts to boot. Both the display and the green 'Power ON' LED illuminate.

The current system pressure and the airend discharge temperature are then displayed in the first line. The compressor package can now be started with the ON key.

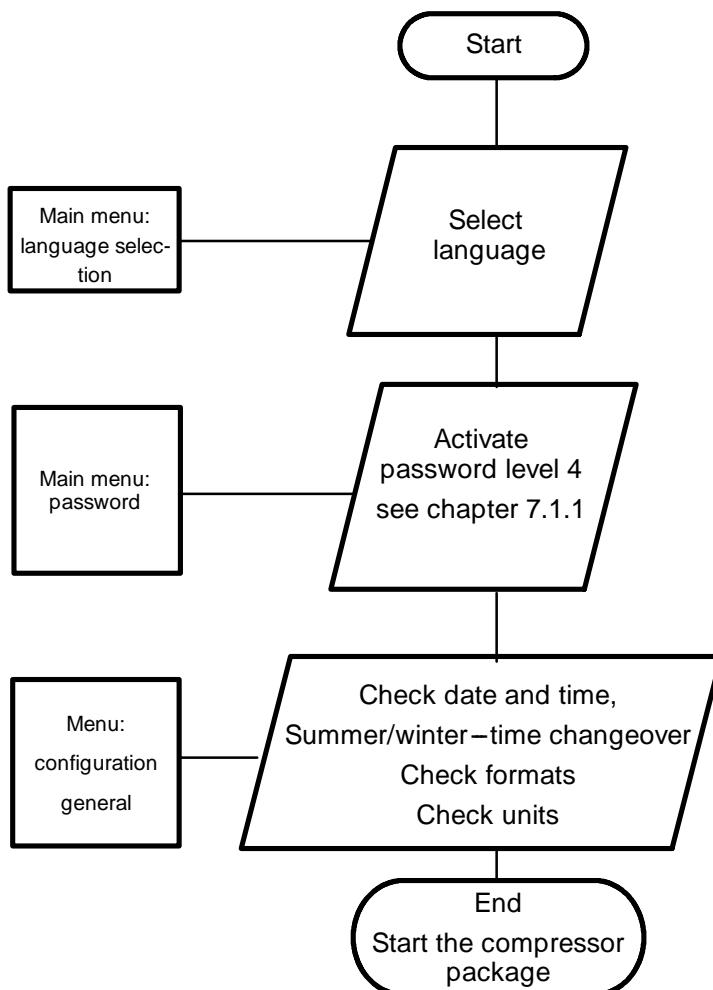

- Setting the language
- ☞ Press and hold the arrow up key (↑) until the language setting appears in the third line of the display.

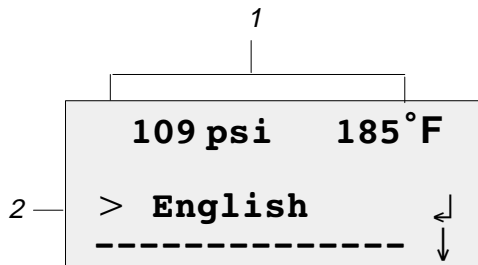

- 1 Current system pressure and airtend discharge temperature
- 2 Display of selected language

- ☞ Press the return key (↵).
- ☞ Select the required language with the arrow keys (↑↓).
- ☞ Confirm with the return key (↵) .
- ☞ Return to the main menu with the “esc” key.
- Enter password
- ☞ Press the arrow key (↑) until password appears in the third line of the display.
- ☞ Press the return key (↵) and the following is displayed:

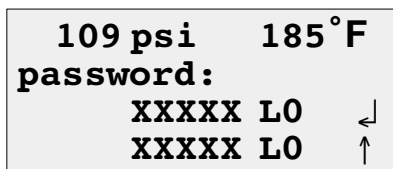

- ☞ By pressing the return key (↵) a flashing cursor appears below the first “X” of the password (XXXXX).
- ☞ Change the first character with the arrow keys (↑↓). Keep pressing the arrow keys until the first “X” is replaced by the character required.
- ☞ Press the return key (↵), the cursor now jumps to the next character in the password.
- ☞ Select the next character with the arrow keys (↑↓).

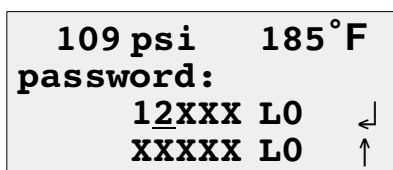

- ☞ Press the return key (↵), the cursor now jumps to the next character in the password.

Using this method, enter the remaining characters of the password for level 4 (12EXP). When the last character of the password is entered with the return key (↵), the activated password level is displayed.

109 psi	185°F	
password:		
XXXXXX	L4	↵
XXXXXX	L4	↑

☞ Exit the password menu by pressing the escape (esc) key.

- Checking settings

(main menu → configuration → general)

☞ Press and hold the arrow keys (↑↓) until “general” appears in the third line of the display.

☞ Press the return key (↵).

The following display appears:

		1	
	109 psi	185°F	
	model		
2	DS 171		
	PN: 7.7001.0		↕

1 *Current system pressure and airend discharge temperature*

2 *Display of selected model*

☞ Press the arrow key (↓), and the following details will be displayed sequentially:

- Version details:
- Model:
- PN: (part number)
- SN: (serial number)

☞ Press the arrow key (↓), the following parameters will be displayed sequentially and can be set by pressing the return key (↵) (see chapter 7.3.1):

- weekday
- date
- time
- summer/winter time
- date format
- time format
- unit of pressure
- unit of temperature

4.8.2 Procedure for initial startup (Expert Mode)

Note

Use this chapter only after reading the complete service manual in detail

When the power supply to the controller is switched on the computer starts to boot. Both the display and the green 'Power ON' LED illuminate.

The current system pressure and the airend discharge temperature are then displayed in the first line. The compressor package can now be started with the ON key.

If personnel are to be given instruction, parameters changed or the settings checked, then the following procedure is recommended:

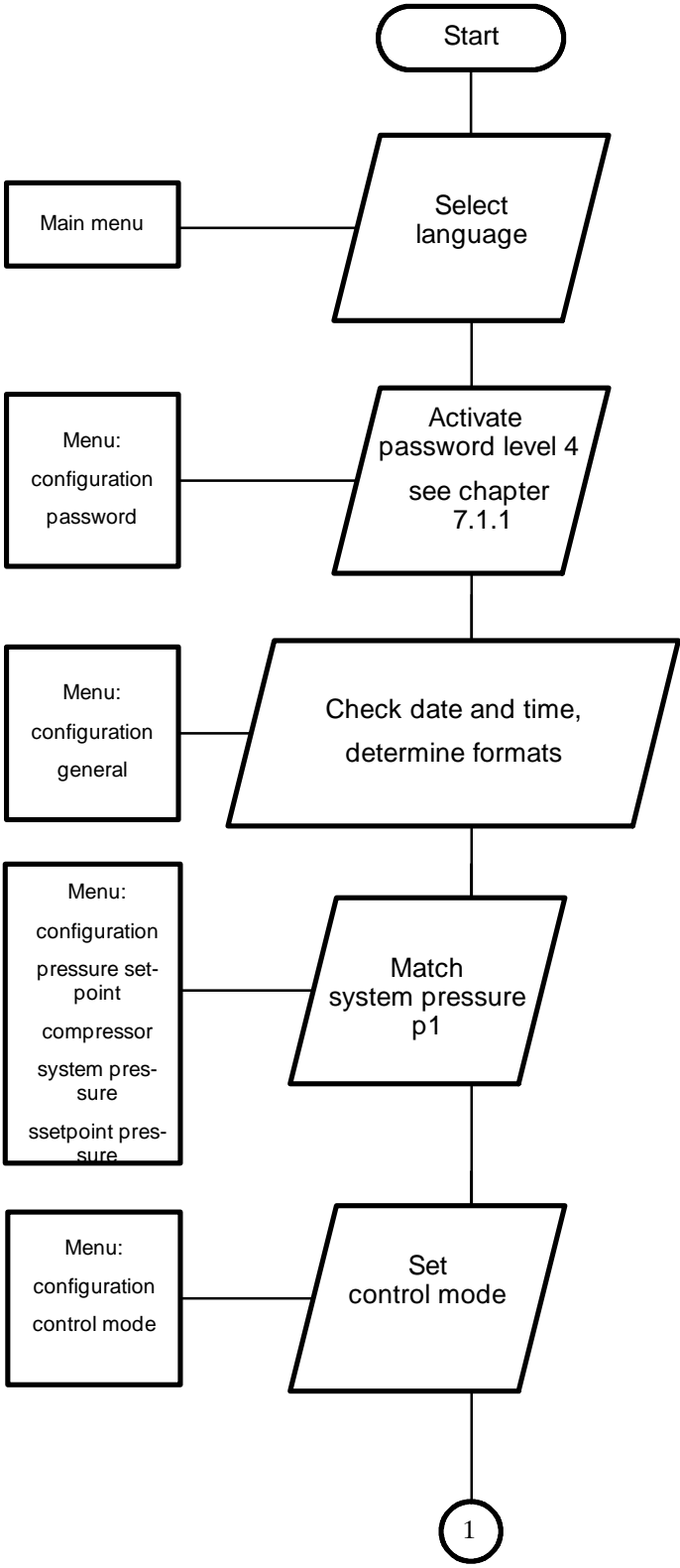

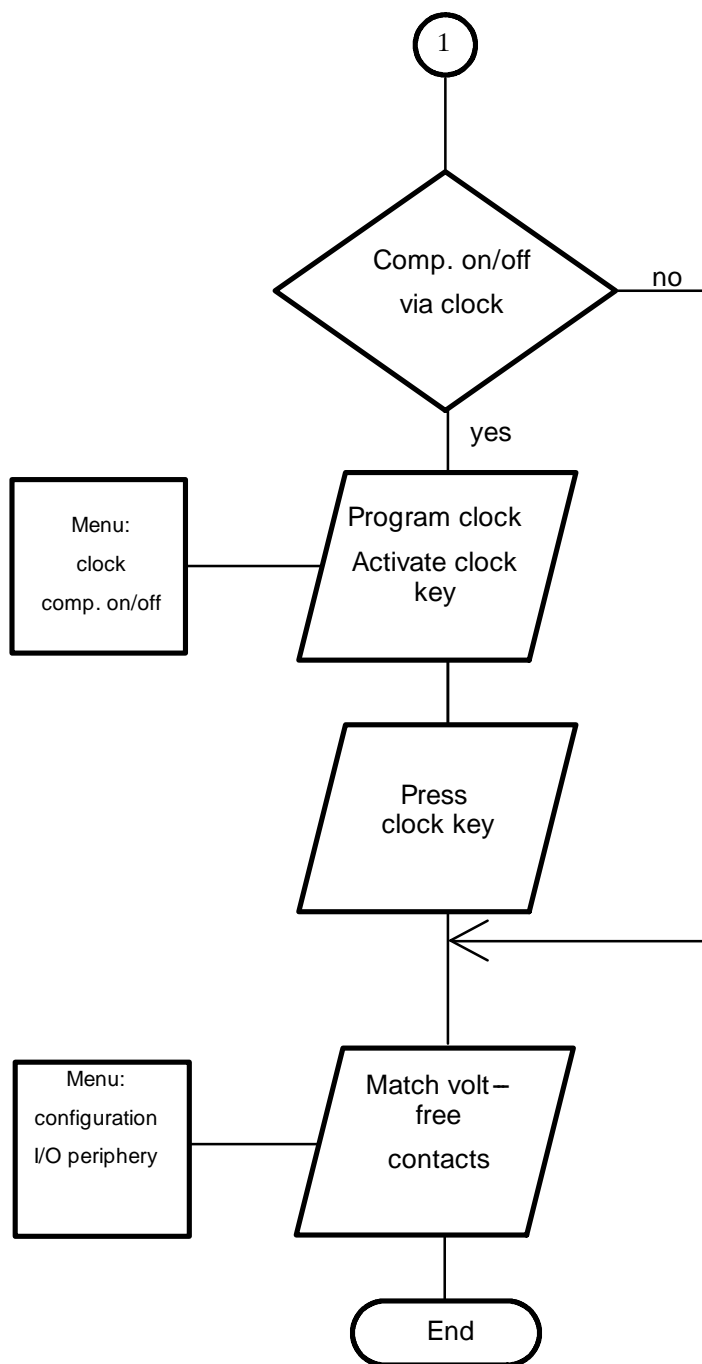

- Setting the language
- ☞ Press and hold the arrow up key (↑) until the language setting appears in the third line of the display.

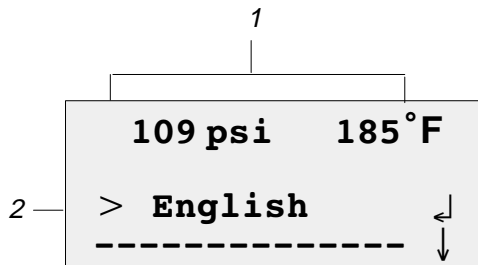

- 1 Current system pressure and airtend discharge temperature
- 2 Display of selected language

- ☞ Press the return key (↵).
- ☞ Select the required language with the arrow keys (↑↓).
- ☞ Confirm with the return key (↵) .
- ☞ Return to the main menu with the "esc" key.

- Enter password
- ☞ Press the arrow key (↑) until password appears in the third line of the display.
- ☞ Press the return key (↵) and the following is displayed:

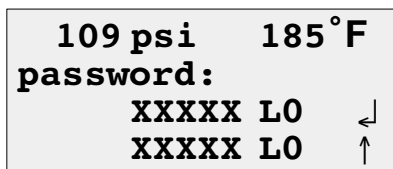

- ☞ By pressing the return key (↵) a flashing cursor appears below the first "X" of the password (XXXXX).
- ☞ Change the first character with the arrow keys (↑↓). Keep pressing the arrow keys until the first "X" is replaced by the character required.
- ☞ Press the return key (↵), the cursor now jumps to the next character in the password.
- ☞ Select the next character with the arrow keys (↑↓).

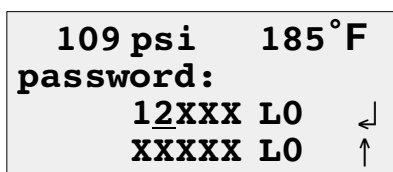

- ☞ Press the return key (↵), the cursor now jumps to the next character in the password.

Using this method, enter the remaining characters of the password for level 4 (12EXP). When the last character of the password is entered with the return key (↵), the activated password level is displayed.

109 psi	185°F	
password:		
XXXXXX	L4	↵
XXXXXX	L4	↑

✎ Exit the password menu by pressing the escape (esc) key.

- Checking settings

(main menu → configuration → general)

✎ Press and hold the arrow keys (↑↓) until “general” appears in the third line of the display.

✎ Press the return key (↵).

The following display appears:

		1	
	109 psi	185°F	
	model		
2	DS 171		
	PN: 7.7001.0		↕

1 Current system pressure and airend discharge temperature

2 Display of selected model

✎ Press the arrow key (↓), and the following details will be displayed sequentially:

- Version details:
- Model:
- PN: (part number)
- SN: (serial number)

✎ Press the arrow key (↓), the following parameters will be displayed sequentially and can be set by pressing the return key (↵) (see chapter 7.3.1):

- weekday
- date
- time
- summer/winter time
- date format
- time format
- unit of pressure
- unit of temperature

- Adjusting system pressure

(main menu → configuration → compressor)

- ☞ In the main menu, press and hold the arrow key (↑) until “configuration” appears in the third line of the display.
- ☞ Press the return key (↵).

The following display appears:

```

109 psi   185°F
general
pressure settings ↵
control mode  ⬆
    
```

- ☞ Press the return key (↵) when the pressure settings appear in the third line of the display; “compressor” now appears in the third line.
- ☞ Press the return key (↵) to display system pressure in the third line of the display.
- ☞ Press the return key (↵) again and the following display appears.

```

109 psi   185°F
setpoint pressure
p1 SP: 109psi ↵
-SD: 7.3psi ⬆
    
```

- ☞ Press the return key (↵) and a flashing cursor appears below value p1.
- ☞ Increase the setpoint pressure p1 with the arrow up key (↑) and decrease it with the arrow down key (↓).
- ☞ Enter the changed setpoint pressure with the return key (↵).
- ☞ Press the arrow down key once (↓), so that the switching differential –SD appears in the third line of the display.
- ☞ Press the return key and a flashing cursor appears below the switching differential –SD.
- ☞ Increase the switching differential –SD with the arrow up key (↑) and decrease it with the arrow down key (↓).
- ☞ Enter the new value with the return key (↵).

(see also chapter 7.3.2.1.1).

- Control mode

(main menu → configuration → control mode)

- ☞ Keep pressing the arrow keys (↑↓) in the control mode menu option until “local mode” appears in the second line of the display and then press the return key (↵).

```

109 psi   185°F
local mode
> Quadro ↵
control mode ⬆
    
```

Sigma Control is provided with various pressure control modes (see also chapter 7.3.3).

- ☞ Press and hold the arrow keys (↑↓) in local mode until the required control mode appears in the third line of the display.
- ☞ Press the return key (↵) to confirm the selection.

- Programming the clock

(main menu → clock)

- ☞ In the main menu, press and hold the arrow key (↑) until “clock” appears in the third line of the display.
- ☞ Press the return key (↵).

The following display appears:

```
109 psi    185 °F
comp. ON/OFF
      . . .
```

- ☞ Press the return key (↵) again and the following display appears.

```
109 psi    185 °F
clock key:  j
ON/OFF day
```

- ☞ Press the arrow down key once (↓), so that ON/OFF day appears in the third line of the display.
- ☞ Press the return key (↵) to set the first switching point. Four switching points are available.

```
109 psi    185 °F
1 | ON/OFF day
ON: 05:20
OFF: 12:35
```

- ☞ Press the return key (↵) and a flashing cursor appears below corresponding time.
- ☞ The time can be increased or decreased with the arrow keys (↑↓).
- ☞ Enter the selected time with the return (↵) key.

A daily schedule with four switching points is available. In this schedule the compressor package can be started with the ON time and stopped with the OFF time. The daily schedule can be interrupted by the weekly schedule, a fact that could be useful at weekends, for example. The weekly schedule can also be interrupted by the yearly schedule (see also chapter 7.2.1).

When all switching points have been set, the menu is exited with the escape “esc” key.

- Activate the clock key
- ☞ Press the arrow up key (↑) once, so that “clock key: n” appears in the third line of the display.
- ☞ Press the return key (↵), a flashing cursor appears below the “n”.
- ☞ Change the entry from “n” to “y” with the arrow up key (↑).
- ☞ Confirm the change with the return key (↵).

4.8.3 Correcting the package pressure

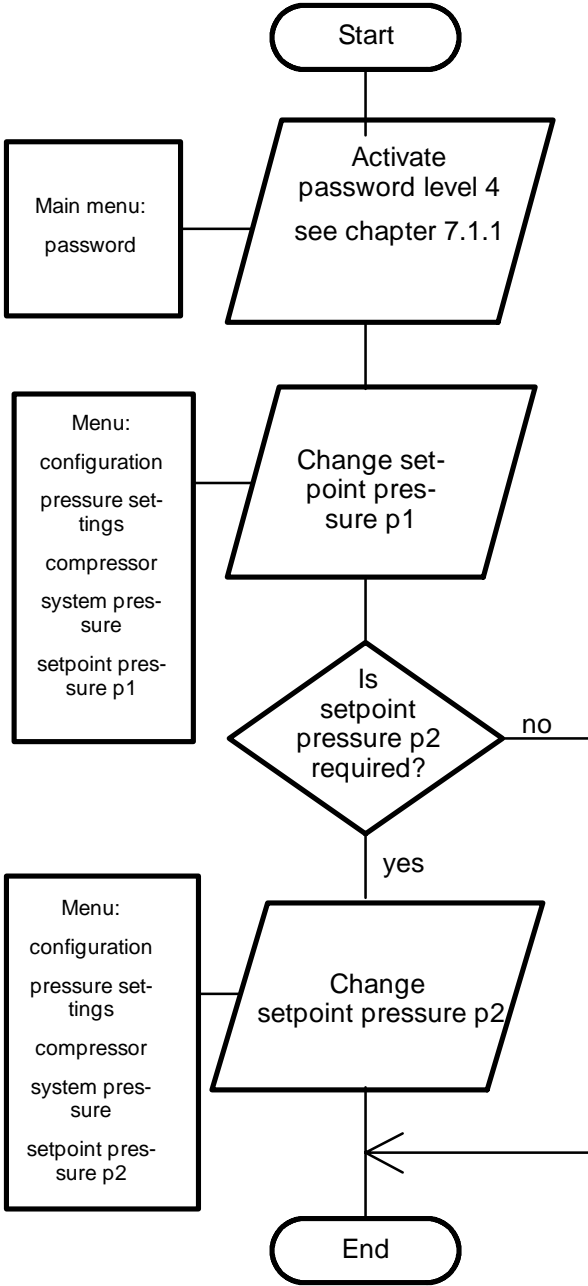

Note:

The pressure parameters can only be set within predetermined limits:

Package pressure \geq **SP (p1)** \geq $P_{\text{cut-in min}} + SD$

SP (switching point): when system pressure reaches this switching point (p1), the compressor package switches to idle.

SD (differential pressure): if pressure falls below the SP (p1) – SD, the compressor package switches to load.

- Enter password
- ☞ Press the arrow key (↑) until password appears in the third line of the display.
- ☞ Press the return key (↵) and the following is displayed:

```
109 psi   185°F
password:
  XXXXX L0  ↵
  XXXXX L0  ↑
```

- ☞ By pressing the return key (↵) a flashing cursor appears below the first "X" of the password (XXXXX).
- ☞ Change the first character with the arrow keys (↑↓). Keep pressing the arrow keys until the first "X" is replaced by the character required.
- ☞ Press the return key (↵), the cursor now jumps to the next character in the password.
- ☞ Select the next character with the arrow keys (↑↓).

```
109 psi   185°F
password:
  12XXX L0  ↵
  XXXXX L0  ↑
```

- ☞ Press the return key (↵), the cursor now jumps to the next character in the password.

Using this method, enter the remaining characters of the password for level 4 (12EXP). When the last character of the password is entered with the return key (↵), the activated password level is displayed.

```
109 psi   185°F
password:
  XXXXX L4  ↵
  XXXXX L4  ↑
```

- ☞ Exit the password menu by pressing the escape (esc) key.

- Adjusting system pressure
(main menu → configuration → compressor)

- ☞ In the main menu, press and hold the arrow key (↑) until "configuration" appears in the third line of the display.
- ☞ Press the return key (↵).

The following display appears:

```
109 psi   185°F
general
pressure settings ↵
control mode     ↓
```

- ☞ Press the return key (↵) when the pressure settings appear in the third line of the display; "compressor" now appears in the third line.

- ☞ Press the return key (↵) to display system pressure in the third line of the display.
- ☞ Press the return key (↵) again and the following display appears.

```
109 psi  185 °F
setpoint pressure
p1 SP:  109psi ↵
-SD:   7.3psi ⇅
```

- ☞ Press the return key (↵) and a flashing cursor appears below value p1.
- ☞ Increase the setpoint pressure p1 with the arrow up key (↑) and decrease it with the arrow down key (↓).
- ☞ Enter the changed setpoint pressure with the return key (↵).
- ☞ Press the arrow down key once (↓), so that the switching differential –SD appears in the third line of the display.
- ☞ Press the return key and a flashing cursor appears below the switching differential –SD.
- ☞ Increase the switching differential –SD with the arrow up key (↑) and decrease it with the arrow down key (↓).
- ☞ Enter the new value with the return key (↵).

(see also chapter 7.3.2.1.1).

- Change setpoint pressure p2
- ☞ When the switching differential –SD for setpoint pressure p1 has been set, press the arrow key (↓) once. The following display appears:

```
109 psi  185 °F
-SD:   7.3psi
p2 SP:  104psi ↵
-SD:   7.3psi ⇅
```

- ☞ Press the return key (↵) and a flashing cursor appears below value p2.
- ☞ Increase the setpoint pressure p2 with the arrow up key (↑) and decrease it with the arrow down key (↓).
- ☞ Enter the changed setpoint pressure with the return key (↵).
- ☞ Press the arrow down key once (↓), so that the switching difference –SD appears in the third line of the display.
- ☞ Press the return key (↵) and a flashing cursor appears below the switching differential –SD.
- ☞ Increase the switching differential –SD with the arrow up key (↑) and decrease it with the arrow down key (↓).
- ☞ Enter the new value with the return key (↵).

(see also chapter 7.3.2.1.1).

4.8.4 Carrying out maintenance

Attention!

When the maintenance is complete the remaining interval (3) must be reset to the default service interval (4).

Note

Password level 4 access is required to carry out changes to the service interval counters.

- Enter password
- ☞ Press the arrow key (↑) until password appears in the third line of the display.
- ☞ Press the return key (↵) and the following is displayed:

```
109 psi  185°F
password:
  XXXXX L0  ↵
  XXXXX L0  ↑
```

- ☞ By pressing the return key (↵) a flashing cursor appears below the first "X" of the password (XXXXX).
- ☞ Change the first character with the arrow keys (↑↓). Keep pressing the arrow keys until the first "X" is replaced by the character required.
- ☞ Press the return key (↵), the cursor now jumps to the next character in the password.
- ☞ Select the next character with the arrow keys (↑↓).

```
109 psi  185°F
password:
  12XXX L0  ↵
  XXXXX L0  ↑
```

- ☞ Press the return key (↵), the cursor now jumps to the next character in the password.

Using this method, enter the remaining characters of the password for level 4 (12EXP). When the last character of the password is entered with the return key (↵), the activated password level is displayed.

```
109 psi  185°F
password:
  XXXXX L4  ↵
  XXXXX L4  ↑
```

- ☞ Exit the password menu by pressing the escape (esc) key.

- Resetting the service hours

The remaining hours in the corresponding service hours counter can be individually reset after completion of maintenance.

The following service intervals are provided:

Oil filter, oil separator, oil change, air filter, V-belts change, V-belts tensioning, bearings change, bearings maintenance, electrical equipment.

This means, for example, that when the V-belts have been tensioned, the corresponding service interval must be reset. The reset for V-belt tensioning is located two lines below the phrase "V-belt tension".

- ☞ Press the arrow down key (↓) 10 times, until "maintenance" appears in the third line of the display.

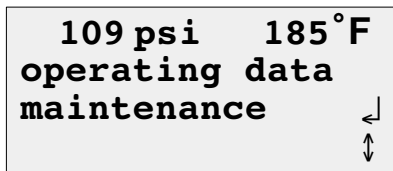

- ☞ Press the return key (↵), the following display appears.

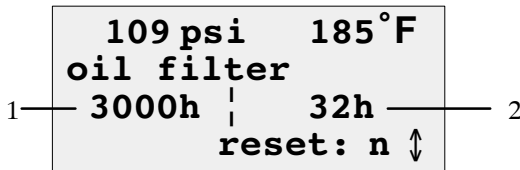

The service counter is a down counter. The remaining hours to the next service (2) are shown, together with the service interval (1).

- ☞ By pressing the arrow down key (↓) the other service intervals are displayed.

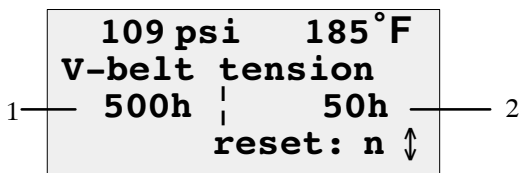

- ☞ Press the arrow key (↓) once, "reset" appears in the third line of the display.

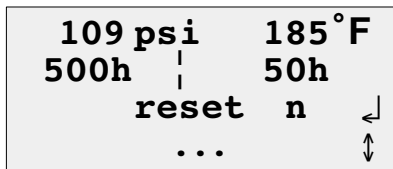

- ☞ Press the return key (↵), a flashing cursor appears below the "n".
- ☞ Change the reset display from "n" to "y" with the arrow key (↑).
- ☞ Confirm with the enter key (↵). The counter resets to the default service interval. At the same time the reset display changes from "y" to "n".

4.8.5 The compressor package is to be operated with a base load sequencer

4.8.5.1 MIC 4000 as an example

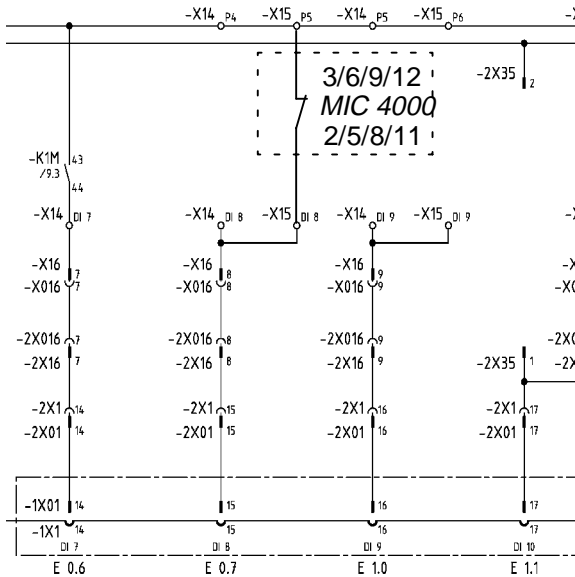

Compressors with ribbon cable adapter

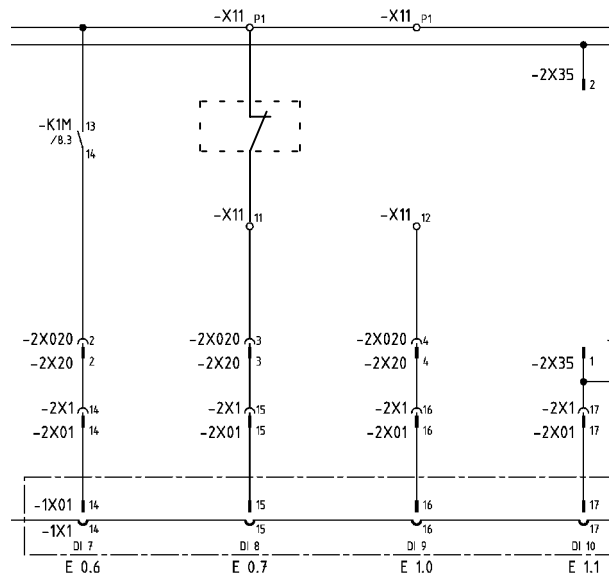

Compressors without ribbon cable adapter, SX, SM and SK before modification to spring terminals

I 0.7external load/idle

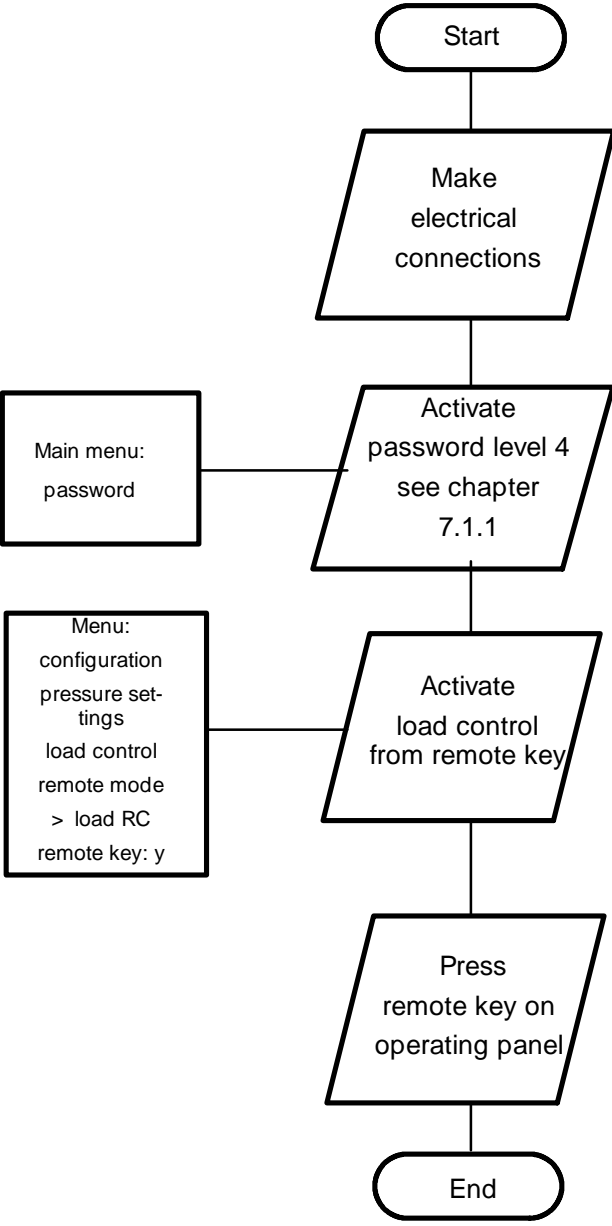

- Enter password
- ☞ Press the arrow key (↑) until password appears in the third line of the display.
- ☞ Press the return key (↵) and the following is displayed:

```
109 psi  185°F
password:
XXXXX L0  ↵
XXXXX L0  ↑
```

- ☞ By pressing the return key (↵) a flashing cursor appears below the first "X" of the password (XXXXX).
- ☞ Change the first character with the arrow keys (↑↓). Keep pressing the arrow keys until the first "X" is replaced by the character required.
- ☞ Press the return key (↵), the cursor now jumps to the next character in the password.
- ☞ Select the next character with the arrow keys (↑↓).

```
109 psi  185°F
password:
12XXX L0  ↵
XXXXX L0  ↑
```

- ☞ Press the return key (↵), the cursor now jumps to the next character in the password.

Using this method, enter the remaining characters of the password for level 4 (12EXP). When the last character of the password is entered with the return key (↵), the activated password level is displayed.

```
109 psi  185°F
password:
XXXXX L4  ↵
XXXXX L4  ↑
```

- ☞ Exit the password menu by pressing the escape (esc) key.

- Activating load control

(main menu → configuration)

- ☞ In the main menu, press and hold the arrow up key (↑) until “configuration” appears in the third line of the display.
- ☞ Press the return key (↵).

The following display appears:

```

109 psi   185°F
general
pressure settings ↵
control mode  ⬆
  
```

- ☞ Press the return key (↵).
- ☞ Press the arrow down key (↓) four times, until “load control” appears in the third line of the display.
- ☞ Press the return key (↵), the following display appears.

```

109 psi   185°F
selection
-----
load control  ⬆
  
```

- ☞ Press the arrow down key (↓) seven times and the following appears in the display.

```

109 psi   185°F
remote mode
> p1      ↵
remote key: n  ⬆
  
```

- ☞ Press the return key (↵), a flashing cursor appears in the third line of the display.
- ☞ Press the arrow keys (↑↓) until “load RC” appears in the third line of the display.
- ☞ Enter the new value with the return key (↵).
- Activating the remote key
 - ☞ Press the arrow down key (↓) once until “remote key: n” appears in the third line of the display.
 - ☞ Press the return key (↵), a flashing cursor appears below the “n”.
 - ☞ Change the entry from “n” to “y” with the arrow keys (↑↓).
 - ☞ Confirm activation of the remote key with the return (↵) key. The following display appears:

```

109 psi   185°F
> load RC
remote key: j  ↵
                ⬆
  
```

(see also chapter 7.3.2.3).

The pressure increase dpl becomes important if the rated package pressure is exceeded because of a period of external load that is too long. It then acts as the upper shutdown value.

4.8.5.2 MVS 8000 as an example

Automatic/manual mode

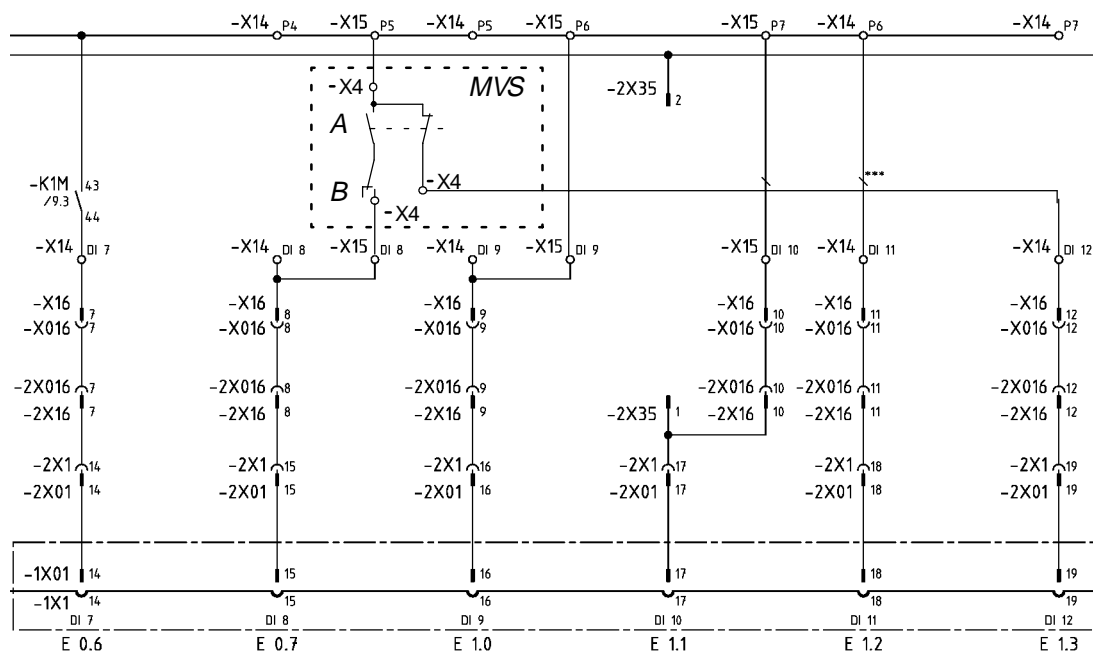

- A Changeover between automatic and manual modes
- B Load/idle contact in the MVS
- I0.7 External load/idle
- I1.3 Load control changeover, local ↔ load RC

“Motor running” and “control on” messages

Wire the “motor running” and “control ON” messages from the compressor to the MVS.

Attention!

It is imperative that output O0.3 “control ON” is used for the “alarm compressor X” message to the MVS.

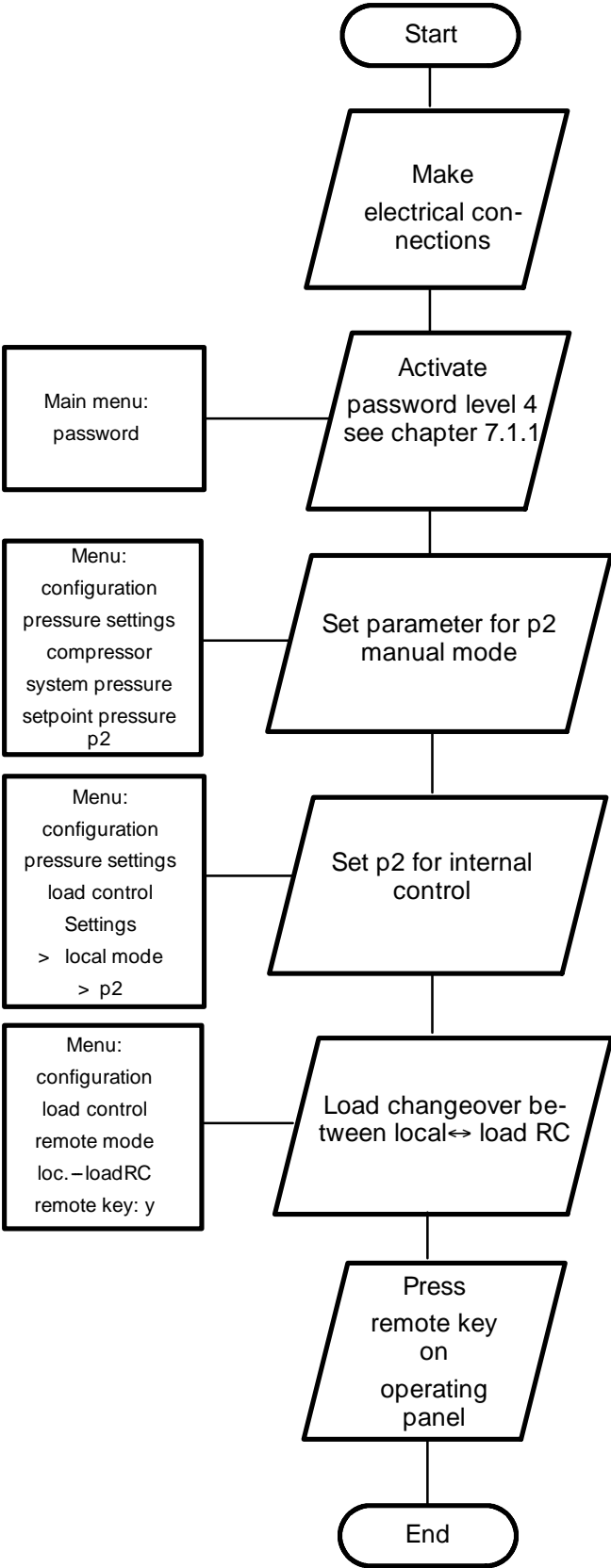

Note:

The setpoint for p2 must result in a reasonable switching combination if all compressor packages are to be controlled in manual mode, i.e. by their own default pressure settings.

- Enter password
- ☞ Press the arrow key (↑) until password appears in the third line of the display.
- ☞ Press the return key (↵) and the following is displayed:

```
109 psi  185°F
password:
XXXXX L0  ↵
XXXXX L0  ↑
```

- ☞ By pressing the return key (↵) a flashing cursor appears below the first "X" of the password (XXXXX).
- ☞ Change the first character with the arrow keys (↑↓). Keep pressing the arrow keys until the first "X" is replaced by the character required.
- ☞ Press the return key (↵), the cursor now jumps to the next character in the password.
- ☞ Select the next character with the arrow keys (↑↓).

```
109 psi  185°F
password:
12XXX L0  ↵
XXXXX L0  ↑
```

- ☞ Press the return key (↵), the cursor now jumps to the next character in the password.

Using this method, enter the remaining characters of the password for level 4 (12EXP). When the last character of the password is entered with the return key (↵), the activated password level is displayed.

```
109 psi  185°F
password:
XXXXX L4  ↵
XXXXX L4  ↑
```

- ☞ Exit the password menu by pressing the escape (esc) key.

- Pressure parameter for manual mode

(main menu → configuration)

- ☞ In the main menu, press and hold the arrow up key (↑) until “configuration” appears in the third line of the display.
- ☞ Press the return key (↵).

The following display appears:

```
109 psi  185 °F
general
pressure settings ↵
control mode      ↓
```

- ☞ Press the return key (↵) when “pressure settings” appears in the third line of the display; “compressor” now appears in the third line.
- ☞ Press the return key (↵) to display setpoint pressure in the third line of the display.
- ☞ Press the return key (↵) again and the following display appears.

```
109 psi  185 °F
setpoint press.
p1 SP: 7.5bar ↵
-SD: 0.5bar  ↓
```

- ☞ Press the arrow down key (↓) twice, the following display appears.

```
109 psi  185 °F
-SD: 0.5bar
p2 SP: 7.2bar ↵
-SD: 0.5bar  ↓
```

- ☞ Press the return key (↵) and a flashing cursor appears below value p2.
- ☞ Increase the setpoint pressure p2 with the arrow up key (↑) and decrease it with the arrow down key (↓).
- ☞ Enter the new setpoint pressure with the return key (↵).
- ☞ Press the arrow down key once (↓), so that the switching differential –SD appears in the third line of the display.
- ☞ Press the return key (↵) and a flashing cursor appears below the switching differential –SD.
- ☞ Increase the switching differential –SD with the arrow up key (↑) and decrease it with the arrow down key (↓).
- ☞ Enter the new value with the return key (↵).

(see also chapter 7.3.2.1.1).

- Setting p2 for internal control

(main menu → configuration)

- ☞ In the main menu, press and hold the arrow up key (↑) until “configuration” appears in the third line of the display.
- ☞ Press the return key (↵).

The following display appears:

```

109 psi   185°F
general
pressure settings ←
control mode  ↓
  
```

- ☞ Press the return key (↵) when “pressure settings” appears in the third line of the display.
- ☞ Press the arrow down key (↓) four times, until “load control” appears in the third line of the display.
- ☞ Press the return key (↵), the following display appears.

```

109 psi   185°F
selection
-----
load control  ↓
  
```

- ☞ Press the arrow down key (↓) three times and the following appears in the display.

```

109 psi   185°F
local mode
> p1      ←
...      ↓
  
```

- ☞ Press the return key (↵) when “local mode” appears in the second line of the display. A flashing cursor appears in the third line.
- ☞ Press the arrow keys (↑↓) until “p2” appears in the third line of the display.
- ☞ Enter the new value with the return key (↵).

- Load control changeover

- ☞ Having set p2 for the internal pressure control, press the arrow down key (↓) four times and the following appears in the display.

```

109 psi   185°F
remote mode
> p1      ←
remote key: n ↓
  
```

- ☞ Press the return key (↵), a flashing cursor appears in the third line of the display.
- ☞ Press the arrow keys (↑↓) until “> loc.–loadRC” appears in the third line of the display.
- ☞ Enter the new value with the return key (↵).

- Activating the remote key
 - ☞ Press the arrow down key (↓) once until “remote key: n” appears in the third line of the display.
 - ☞ Press the return key (↵), a flashing cursor appears below the “n”.
 - ☞ Change the entry from “n” to “y” with the arrow keys (↑↓).
 - ☞ Confirm activation of the remote key with the return (↵) key. The following display appears:

```
109 psi 185°F  
> loc.-loadRC  
remote key:  j ↵
```

(see also chapter 7.3.2.3).

The following status is displayed in automatic mode:

```
109 psi 185°F  
ON key!load RC  
total 001025 h  
load 000980 h ↕
```

The following status is displayed in manual mode:

```
109 psi 185°F  
ON key!load p2  
total 001025 h  
load 000980 h ↕
```

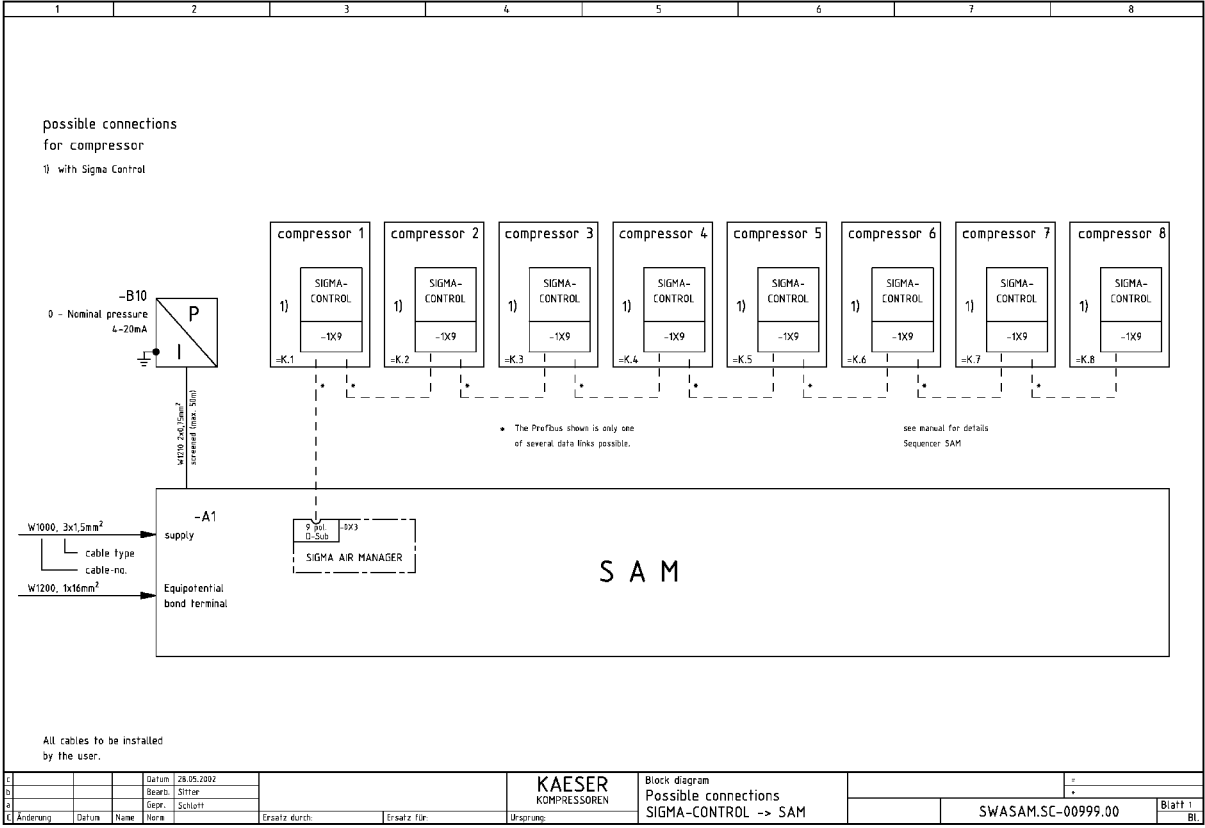

4.8.5.3 VESIS/SAM as an example

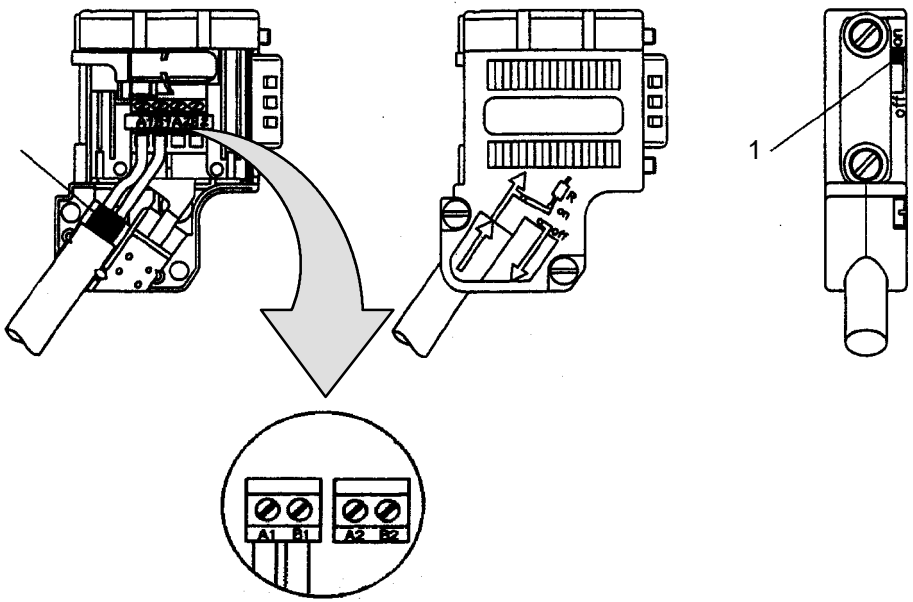

Wiring of the process field bus with the help of the above circuit diagram

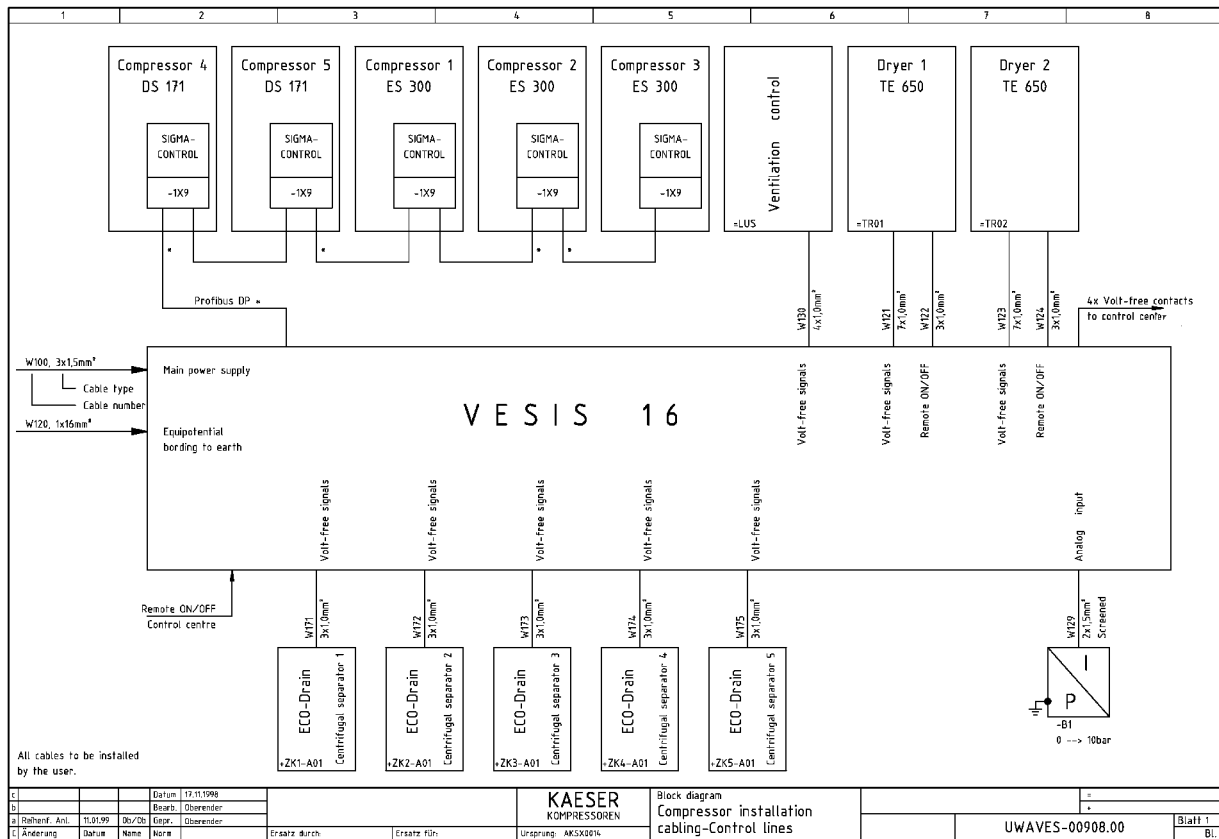

The terminating resistor must be connected in the plugs of the first and last subscribers of a Profibus link.



Wiring of the process field bus with the help of the above circuit diagram

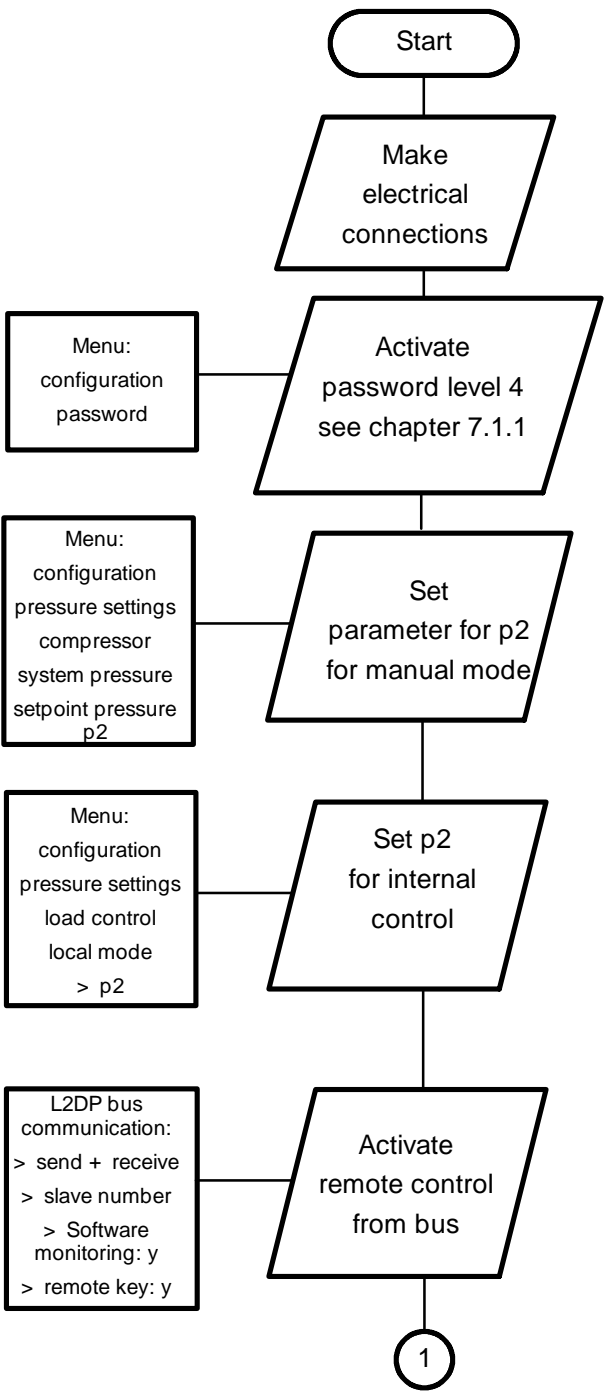

Note:

The setpoint for p2 must result in a reasonable switching combination if all compressor packages are to be controlled in manual mode, i.e. by their own default pressure settings.

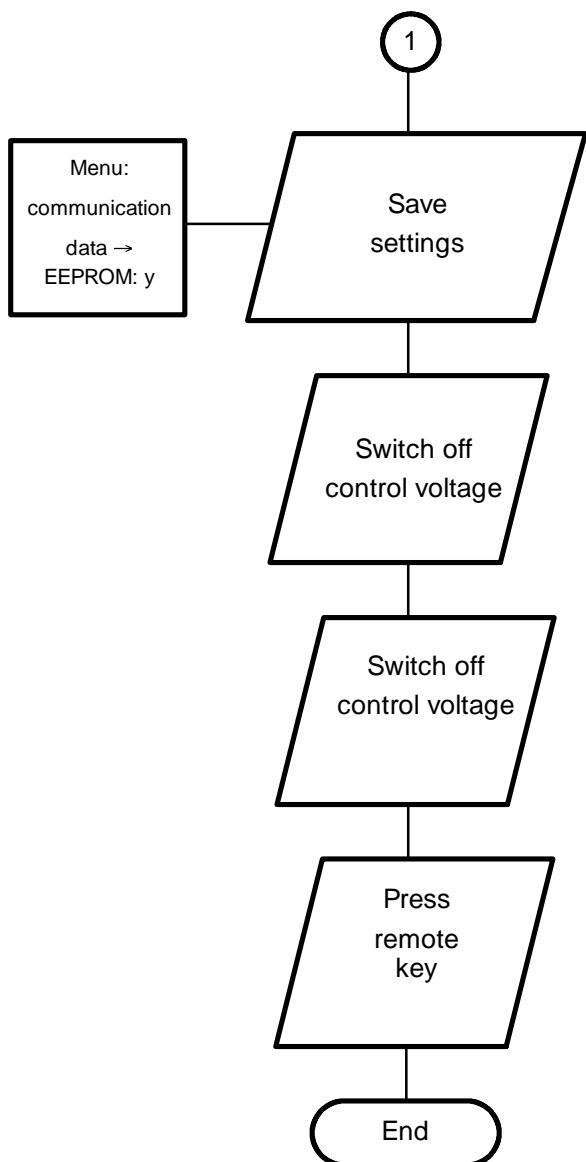

Attention!

An error message appearing after activation is normal. This can be finally reset in active bus mode after all items have been processed.

Attention!

The display returns from “y” to “n” after 10 seconds. No changes should be made to the controller during this period.

- Enter password
- ☞ Press the arrow key (↑) until password appears in the third line of the display.
- ☞ Press the return key (↵) and the following is displayed:

```
109 psi  185°F
password:
XXXXX L0  ↵
XXXXX L0  ↑
```

- ☞ By pressing the return key (↵) a flashing cursor appears below the first "X" of the password (XXXXX).
- ☞ Change the first character with the arrow keys (↑↓). Keep pressing the arrow keys until the first "X" is replaced by the character required.
- ☞ Press the return key (↵), the cursor now jumps to the next character in the password.
- ☞ Select the next character with the arrow keys (↑↓).

```
109 psi  185°F
password:
12XXX L0  ↵
XXXXX L0  ↑
```

- ☞ Press the return key (↵), the cursor now jumps to the next character in the password.

Using this method, enter the remaining characters of the password for level 4 (12EXP). When the last character of the password is entered with the return key (↵), the activated password level is displayed.

```
109 psi  185°F
password:
XXXXX L4  ↵
XXXXX L4  ↑
```

- ☞ Exit the password menu by pressing the escape (esc) key.

- Pressure parameter for manual mode

(main menu → configuration)

- ☞ In the main menu, press and hold the arrow up key (↑) until “configuration” appears in the third line of the display.
- ☞ Press the return key (↵).

The following display appears:

```
109 psi  185 °F
general
pressure settings ↵
control mode      ↓
```

- ☞ Press the return key (↵) when “pressure settings” appears in the third line of the display; “compressor” now appears in the third line.
- ☞ Press the return key (↵) to display setpoint pressure in the third line of the display.
- ☞ Press the return key (↵) again and the following display appears.

```
109 psi  185 °F
setpoint press.
p1 SP: 7.5bar ↵
-SD: 0.5bar  ↓
```

- ☞ Press the arrow down key (↓) twice, the following display appears.

```
109 psi  185 °F
-SD: 0.5bar
p2 SP: 7.2bar ↵
-SD: 0.5bar  ↓
```

- ☞ Press the return key (↵) and a flashing cursor appears below value p2.
- ☞ Increase the setpoint pressure p2 with the arrow up key (↑) and decrease it with the arrow down key (↓).
- ☞ Enter the new setpoint pressure with the return key (↵).
- ☞ Press the arrow down key once (↓), so that the switching differential –SD appears in the third line of the display.
- ☞ Press the return key (↵) and a flashing cursor appears below the switching differential –SD.
- ☞ Increase the switching differential –SD with the arrow up key (↑) and decrease it with the arrow down key (↓).
- ☞ Enter the new value with the return key (↵).

(see also chapter 7.3.2.1.1).

- Setting p2 for internal control

(main menu → configuration)

- ☞ In the main menu, press and hold the arrow up key (↑) until “configuration” appears in the third line of the display.
- ☞ Press the return key (↵).

The following display appears:

```
109 psi  185°F
general
pressure settings ↵
control mode  ⬆
```

- ☞ Press the return key (↵) when “pressure settings” appears in the third line of the display.
- ☞ Press the arrow down key (↓) four times, until “load control” appears in the third line of the display.
- ☞ Press the return key (↵), the following display appears.

```
109 psi  185°F
selection
-----
load control  ⬆
```

- ☞ Press the arrow down key (↓) three times and the following appears in the display.

```
109 psi  185°F
local mode
> p1      ↵
          ⬆
```

- ☞ Press the return key (↵) when “local mode” appears in the second line of the display. A flashing cursor appears in the third line.
- ☞ Press the arrow keys (↑↓) until “p2” appears in the third line of the display.
- ☞ Enter the new value with the return key (↵).

- Activating remote control from the bus

(Main menu → communication)

- ☞ In the main menu, press and hold the arrow key (↑) until “communication” appears in the third line of the display.
- ☞ Press the return key (↵).

The following display appears:

7.5 bar	80 °C R
RS232	(1x7) ↵
RS485	(1x8) ↓

- ☞ Press the arrow down key (↓) twice until “L2DP bus” appears in the third line of the display.
- ☞ Press the return key (↵) when “L2DP bus” appears in the third line of the display. The following display appears:

7.5 bar	80 °C R
> n.a.	↵
	↓

- ☞ Press the return key (↵).
- ☞ Press the arrow up key (↑) until “send+ receive” appears in the third line of the display.
- ☞ Confirm with the return key (↵).
- Setting the slave number
- ☞ Press the arrow down key (↓) twice until “slave no.: 2” appears in the third line of the display.
- ☞ Press the return key (↵), a flashing cursor appears below the number.
- ☞ Set the correct slave number with the arrow keys (↑↓).
- ☞ Enter the selection with the return key (↵).

- Activating software monitoring
- ☞ Press the arrow down key (↓) seven times until “act.: n” appears below “software mon.” in the third line of the display. The following display appears:

```
109 psi   185°F
software mon.
timeout: 8.00s  ↵
                ↓
                act:n
```



```
109 psi   185°F
timeout: 8.00s
act:n     ↵
...      ↓
```

- ☞ Press the return key (↵), a flashing cursor appears below the “n”.
- ☞ Change the entry from “n” to “y” with the arrow keys (↑↓).
- ☞ Enter the selection with the return key (↵).
- Activating the remote key
- ☞ Press the arrow down key (↓) twice until “remote key: n” appears in the third line of the display. The following display appears:

```
109 psi   185°F
...
remote key: n ↵
...      ↑
```

- ☞ Press the return key (↵), a flashing cursor appears below the “n”.
- ☞ Change the entry from “n” to “y” with the arrow keys (↑↓).
- ☞ Enter the selection with the return key (↵).

(see also chapter 7.6.3).

- Saving settings

All important data are stored in an EEPROM that is no-volt safe.

Data are retained even if the buffer battery discharges completely.

If the procedure is activated it takes approximately 30 seconds for the display to change back from “y” to “n”.

Attention!

**No changes should be made to the controller when saving data.
Loss of power when saving can lead to loss of data.**

- ☞ Press and hold the arrow keys (↑↓) until “data →EEPROM” appears in the third line of the display. Press the return key (↵) .
- ☞ Change the entry from “n” to “y” with the arrow keys (↑↓).
- ☞ Confirm with the return key (↵).
- ☞ When the display returns to “n” exit the submenu with the “esc” key.

4.8.6 Two rotary screw compressors in sequence

Attention!

If compressor packages are sequenced the pressure losses between the compressors and the air main must be taken into account.

4.8.6.1 Base load sequencing of two compressor packages with SIGMA CONTROL via the RS 485 interface

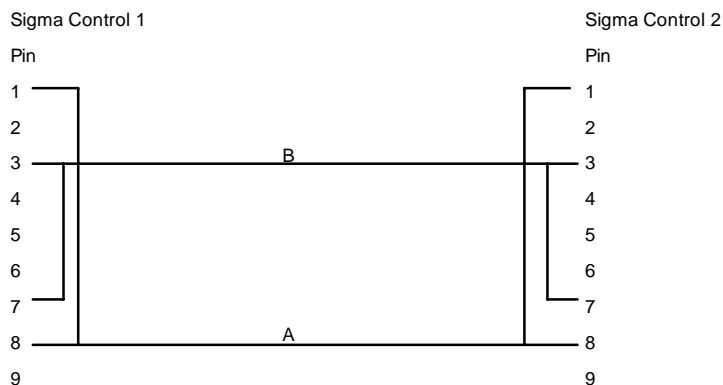

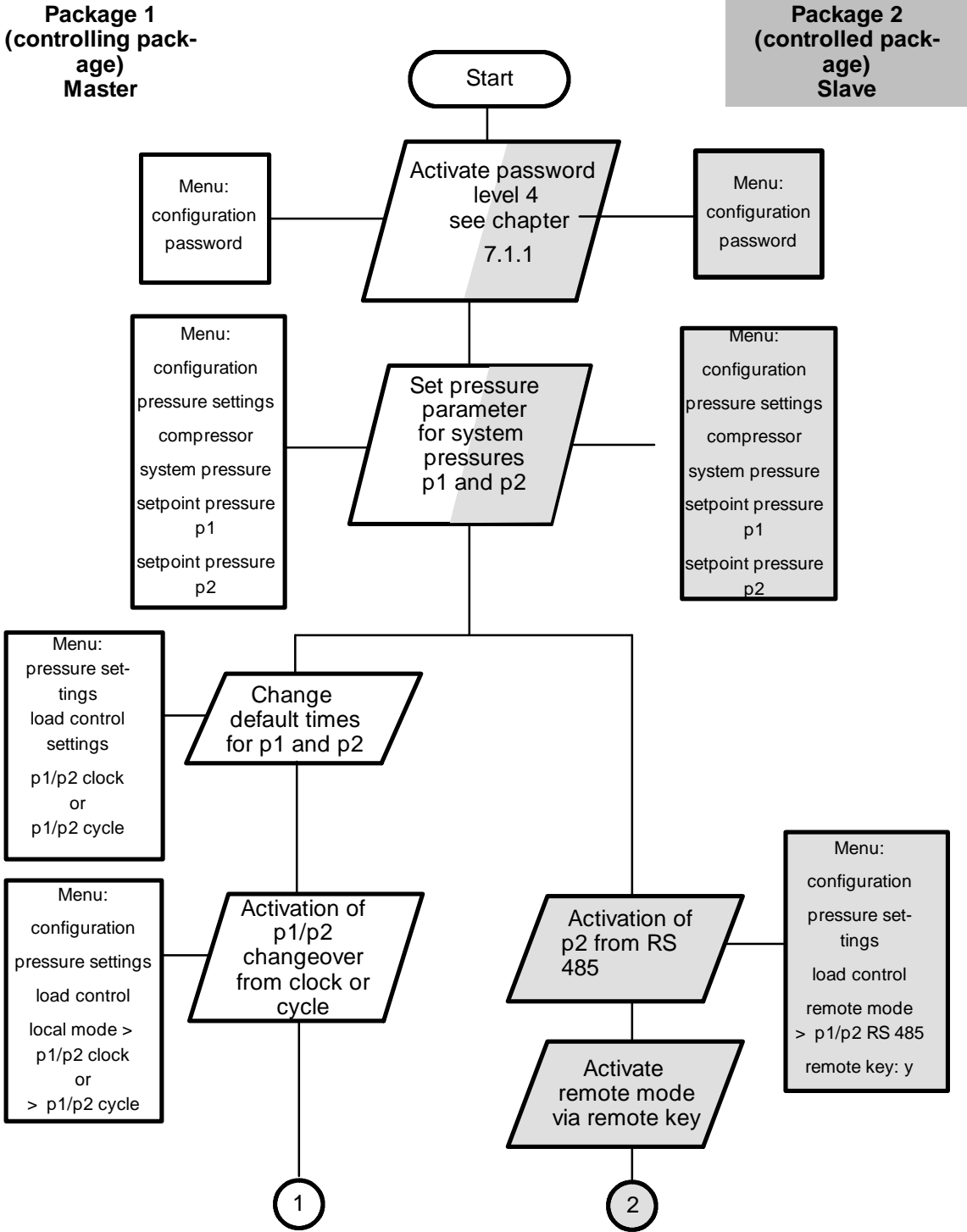

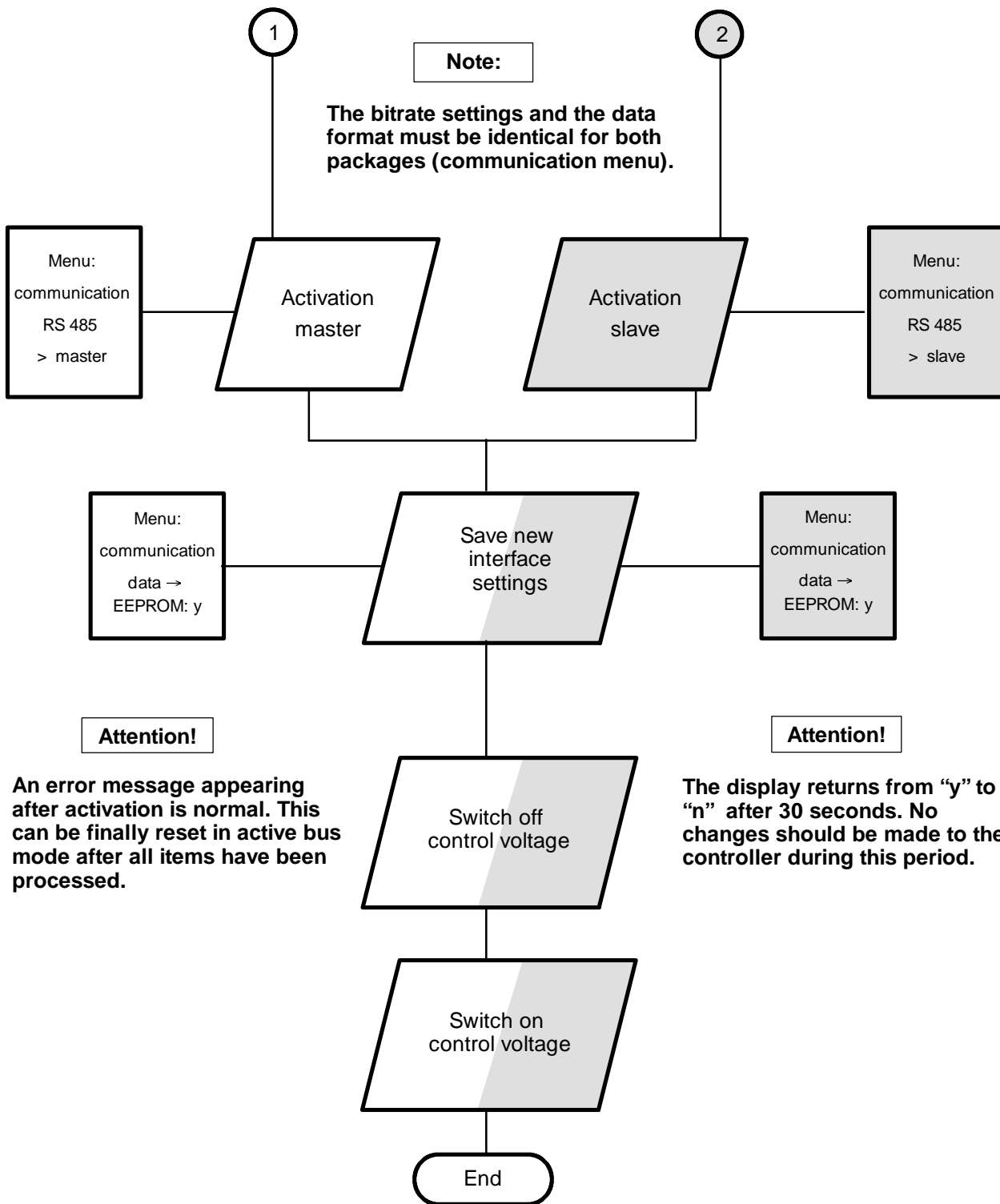

4.8.6.1.1 Settings on both SIGMA CONTROLS

Carry out the following settings on both SIGMA CONTROLS.

- Enter password
- ☞ Press the arrow key (↑) until password appears in the third line of the display.
- ☞ Press the return key (↵) and the following is displayed:

```
109 psi   185°F
password:
XXXXX L0  ↵
XXXXX L0  ↑
```

- ☞ By pressing the return key (↵) a flashing cursor appears below the first "X" of the password (XXXXX).
- ☞ Change the first character with the arrow keys (↑↓). Keep pressing the arrow keys until the first "X" is replaced by the character required.
- ☞ Press the return key (↵), the cursor now jumps to the next character in the password.
- ☞ Select the next character with the arrow keys (↑↓).

```
109 psi   185°F
password:
12XXX L0  ↵
XXXXX L0  ↑
```

- ☞ Press the return key (↵), the cursor now jumps to the next character in the password.

Using this method, enter the remaining characters of the password for level 4 (12EXP). When the last character of the password is entered with the return key (↵), the activated password level is displayed.

```
109 psi   185°F
password:
XXXXX L4  ↵
XXXXX L4  ↑
```

- ☞ Exit the password menu by pressing the escape (esc) key.

- Adjusting system pressure

(main menu → configuration → compressor)

- ☞ In the main menu, press and hold the arrow key (↑) until "configuration" appears in the third line of the display.
- ☞ Press the return key (↵).

The following display appears:

```
109 psi   185°F
general
pressure settings ↵
control mode     ↑↓
```

- ☞ Press the return key (↵) when the pressure settings appear in the third line of the display; “compressor” now appears in the third line.
- ☞ Press the return key (↵) to display system pressure in the third line of the display.
- ☞ Press the return key (↵) again and the following display appears.

109 psi	185 °F
setpoint pressure	
p1 SP:	109psi ↵
-SD:	7.3psi ⬆

- ☞ Press the return key (↵) and a flashing cursor appears below value p1.
- ☞ Increase the setpoint pressure p1 with the arrow up key (↑) and decrease it with the arrow down key (↓).
- ☞ Enter the changed setpoint pressure with the return key (↵).
- ☞ Press the arrow down key once (↓), so that the switching differential –SD appears in the third line of the display.
- ☞ Press the return key and a flashing cursor appears below the switching differential –SD.
- ☞ Increase the switching differential –SD with the arrow up key (↑) and decrease it with the arrow down key (↓).
- ☞ Enter the new value with the return key (↵).

(see also chapter 7.3.2.1.1).

- Change setpoint pressure p2
- ☞ When the switching differential –SD for setpoint pressure p1 has been set, press the arrow key (↓) once. The following display appears:

109 psi	185 °F
-SD:	7.3psi
p2 SP:	104psi ↵
-SD:	7.3psi ⬆

- ☞ Press the return key (↵) and a flashing cursor appears below value p2.
- ☞ Increase the setpoint pressure p2 with the arrow up key (↑) and decrease it with the arrow down key (↓).
- ☞ Enter the changed setpoint pressure with the return key (↵).
- ☞ Press the arrow down key once (↓), so that the switching difference –SD appears in the third line of the display.
- ☞ Press the return key (↵) and a flashing cursor appears below the switching differential –SD.
- ☞ Increase the switching differential –SD with the arrow up key (↑) and decrease it with the arrow down key (↓).
- ☞ Enter the new value with the return key (↵).

(see also chapter 7.3.2.1.1).

4.8.6.1.2 Settings on the master SIGMA CONTROL

Enter the following settings on the SIGMA CONTROL controlling both packages.

- Default times for the changeover between p1 and p2

(Main menu → configuration)

☞ In the main menu, press and hold the arrow up key (↑) until “configuration” appears in the third line of the display.

☞ Press the return key (↵).

The following display appears:

```
109 psi   185 °F
general
pressure settings ↵
control mode ↕
```

☞ Press the return key (↵) when the pressure settings appear in the third line of the display; “compressor” now appears in the third line.

☞ Press the arrow down key (↓) until “load control” appears in the third line of the display.

☞ Press the return key (↵).

a) Clock control

☞ Press the arrow down key (↓) until clock appears below “settings” in the third line of the display. Here the pressure change between p1 and p2 from the internal clock can be entered (see also chapter 7.1.1 and 7.2.1).

```
109 psi   185 °F
* p1/p2 clock
clock      ↵
          ... ↕
```

b) Internal timer control

☞ Press the arrow down key (↓) until p1/p2 cycle appears below “settings” in the third line of the display. Here the pressure change between p1 and p2 from the timer can be entered (see also chapter 7.3.2.3).

```
109 psi   185 °F
* p1/p2 cycle
p1:       24h ↵
p2:       24h ↕
```

When all settings for the load changeover have been entered; the type of load changeover required can be selected.

☞ Press the arrow up key (↑) until local mode appears below load control in the second line of the display.

☞ Press the return key (↵) to select the load changeover.

☞ Select the required load changeover with the arrow keys (↑↓).

☞ Confirm the selected load changeover with the return key (↵). The following display appears:

a)

109 psi	185°F
local mode	
> p1/p2 clock	↵
...	↕

b)

109 psi	185°F
local mode	
> p1/p2 cycle	↵
...	↕

☞ Return to the main menu with the “esc” key.

- Activate master

(main menu → communication)

☞ In the main menu, press and hold the arrow up key (↑) until “communication” appears in the third line of the display.

☞ Press the return key (↵).

The following display appears:

109 psi	185°F
RS232	(1x7) ↵
RS485	(1x8) ↓

☞ Press the arrow down key (↓) once, until “RS485” appears in the third line of the display.

☞ Press the return key (↵) when “RS485” appears in the third line of the display. The following display appears:

109 psi	185°F
> n.a.	↵
	↓

☞ Press the return key (↵).

☞ Press the arrow up key (↑) until “master” appears in the third line of the display.

☞ Enter the setting with the return ↵ key.

☞ Return to the main menu with the “esc” key.

4.8.6.1.3 Settings on the slave SIGMA CONTROL

Enter the following settings on the slave SIGMA CONTROL.

- Activation of p2 from RS 485

(main menu → configuration)

- ☞ In the main menu, press and hold the arrow up key (↑) until “configuration” appears in the third line of the display.
- ☞ Press the return key (↵).

The following display appears:

```
109 psi   185°F
general
pressure settings ↵
control mode  ↓
```

- ☞ Press the return key (↵) when the pressure settings appear in the third line of the display; “compressor” now appears in the third line.
- ☞ Press the arrow down key (↓) until “load control” appears in the third line of the display.
- ☞ Press the return key (↵).
- ☞ Press the return key (↵), a flashing cursor appears below the value to be changed.

```
109 psi   185°F
remote mode
p1 ↵
remote key: n ↓
```

- ☞ Select control mode “p1/p2 RS485” with the arrow keys (↑↓).
- ☞ Press the return key (↵).
- ☞ Press the arrow down key (↓) once, so that “remote key: n” appears in the third line of the display.
- ☞ Press the return key (↵), a flashing cursor appears below the value to be changed.
- ☞ Change the “n” to “y” with the arrow down key (↓).
- ☞ Press the return key (↵).

```
109 psi   185°F
> p1/p2 RS485
remote key: j ↵
... ↓
```

- ☞ Return to the main menu with the “esc” key.

- Activate the slave

(main menu → communication)

- ☞ In the main menu, press and hold the arrow up key (↑) until “communication” appears in the third line of the display.
- ☞ Press the return key (↵).

The following display appears:

109 psi	185 °F
RS232	(1x7) ↵
RS485	(1x8) ↓

- ☞ Press the arrow down key (↓) once, until “RS485” appears in the third line of the display.
- ☞ Press the return key (↵) when “RS485” appears in the third line of the display. The following display appears:

109 psi	185 °F
> n.a.	↵
	↓

- ☞ Press the return key (↵).
- ☞ Press the arrow up key (↑) until “slave” appears in the third line of the display.
- ☞ Enter the setting with the return (↵) key.
- ☞ Return to the main menu with the “esc” key.

4.8.6.1.4 Settings on both SIGMA CONTROLS

Carry out the following settings on both SIGMA CONTROLS.

All important data are stored in an EEPROM that is no-volt safe.

Data are retained even if the buffer battery discharges completely.

If the procedure is activated it takes approximately 30 seconds for the display to change back from “y” to “n”.

Attention!

**No changes should be made to the controller when saving data.
Loss of power when saving can lead to loss of data.**

- ☞ Press and hold the arrow keys (↑↓) until “data →EEPROM” appears in the third line of the display. Press the return key (↵) .
- ☞ Change the entry from “n” to “y” with the arrow keys (↑↓).
- ☞ Confirm with the return key (↵).
- ☞ When the display returns to “n” exit the submenu with the “esc” key.

4.8.6.2 Sequencing SIGMA and pressure switch controlled compressors

- Example 1

A BS 51 with SIGMA CONTROL and an existing SK 26 are to supply the demand at week-ends and during the night.

Recommendation:

The pressure switch settings of the SK 26 should lie exactly between the programmed pressures of the BS 51.

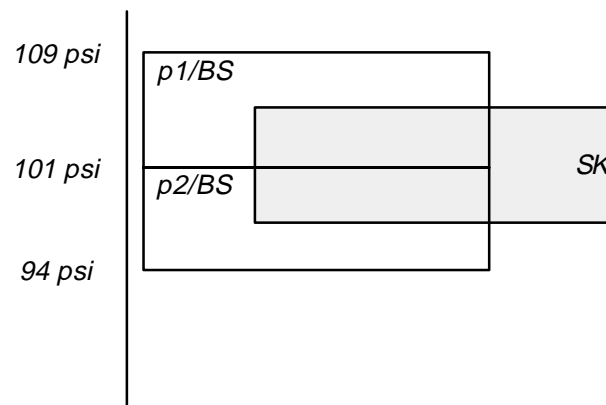

This means that only the submenu p1/p2 of the BS 51 is to be programmed.

If the switching point p2 is activated over the weekend and during the night then the SK 26 is automatically selected as the base load machine.

- ☞ Change to p1/p2 clock (load control, local mode)
- ☞ Enter the required values (SP and SD) for p1 and p2
- ☞ Activate the switching points on the clock

● Example 2

Two machines of the same capacity, one with SIGMA CONTROL and the other with conventional control, are to be sequenced as base and peak load machines.

- ☞ Program the submenu p1/p2 on the SIGMA CONTROL machine according to the base load sequence requirements.
- ☞ Enter the required values (SP and SD) for p1 and p2.
- ☞ Enter the changeover delays and/or periods in the load control menu.
- ☞ One of the volt-free contacts O0.3, O0.4 or O0.5 must be functionally allocated to the p1/p2 submenu.

This contact is then used for the changeover between two pressure switches in the existing "old compressor package" (see example circuit diagram).

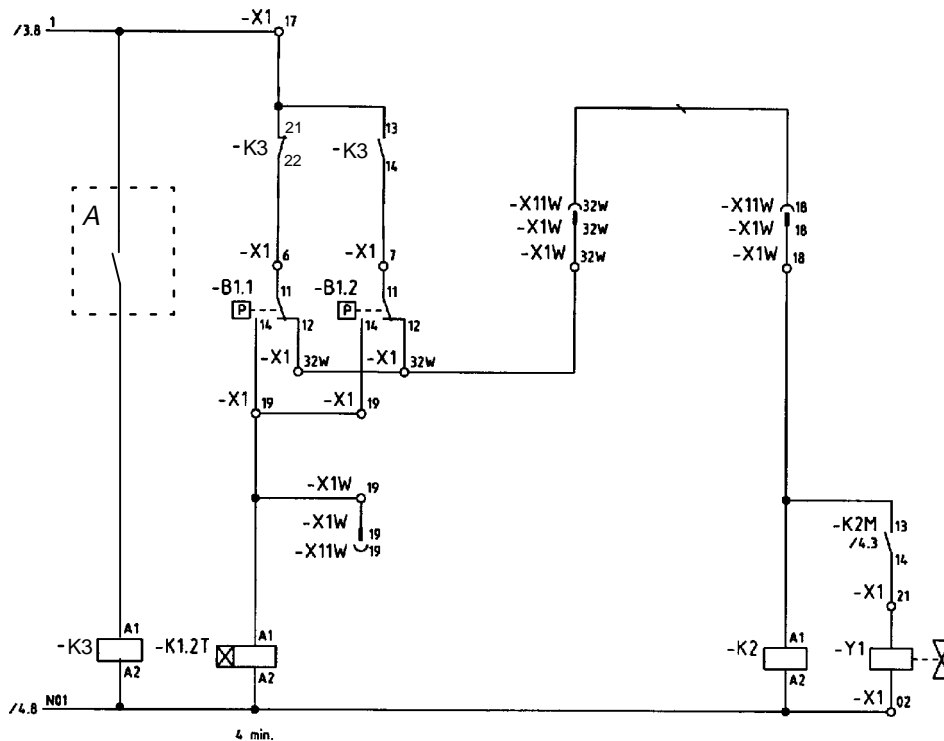

- A open: Sigma Control – package running with setpoint pressure p2
- A closed: Sigma Control – package running with setpoint pressure p1

- Examples of the time settings
 1. Two equivalent machines are to have equal duty cycles.
 - 1.1 Daily switch between p1 and p2 after 24 hours. The compressor package starts with air main pressure p2 at 0.00 hours.

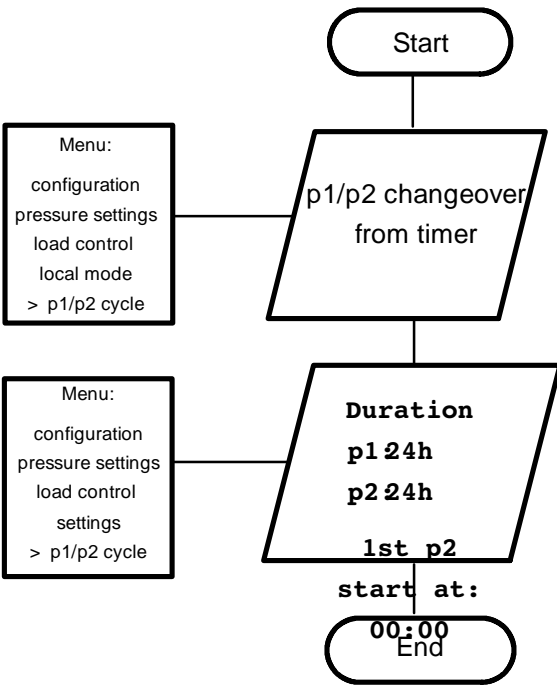

- 1.2 Equal duty cycle during the day.

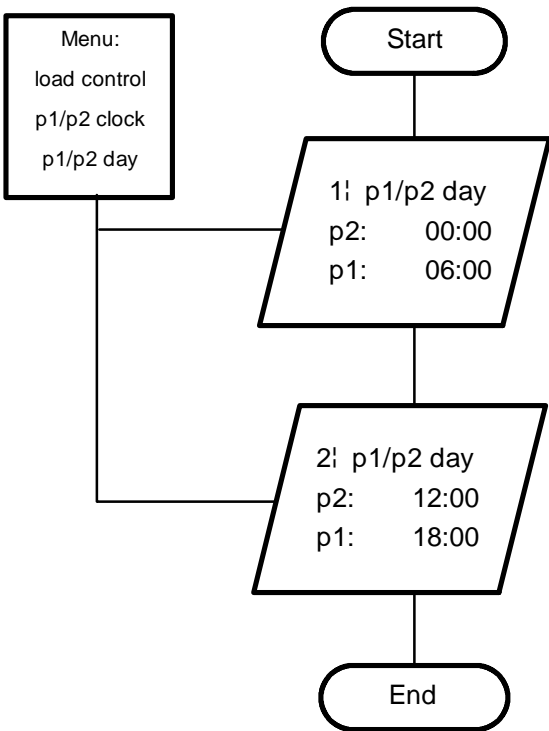

1.3 Equal duty cycle during the week

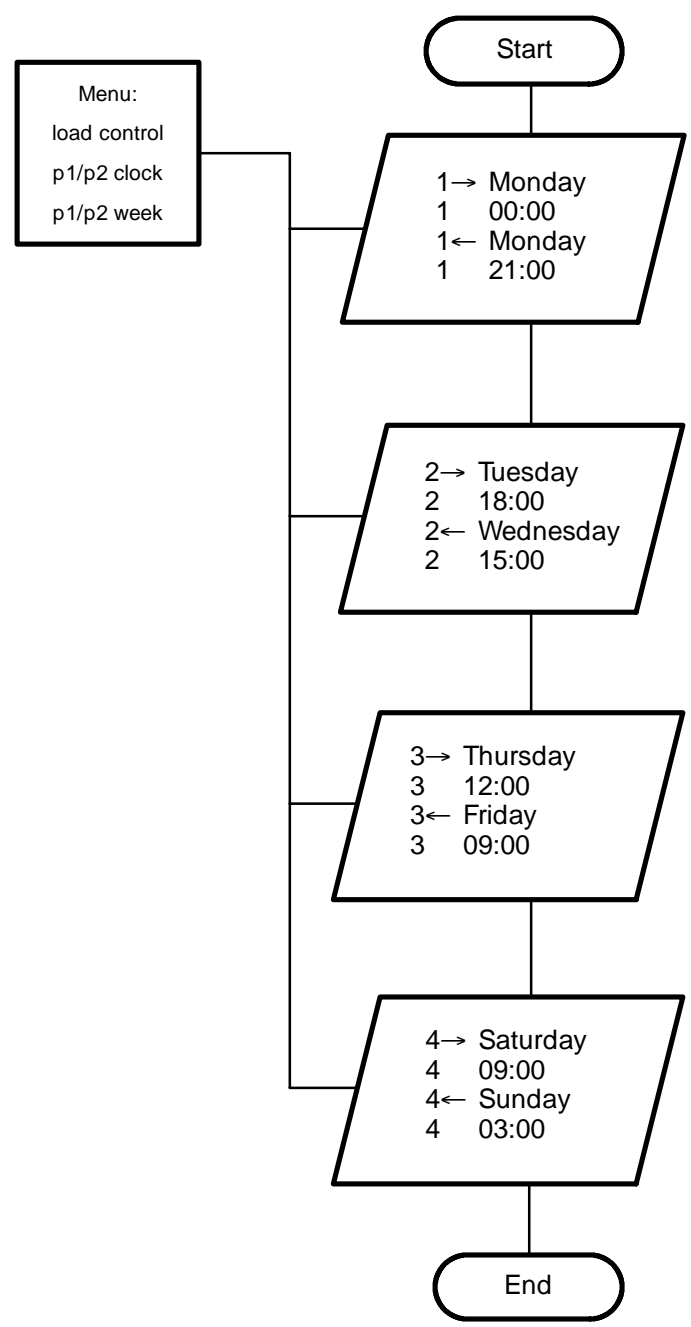

1.4 A compressor package with a lower capacity that is operated as a slave is to work as a base machine at night and at weekend.

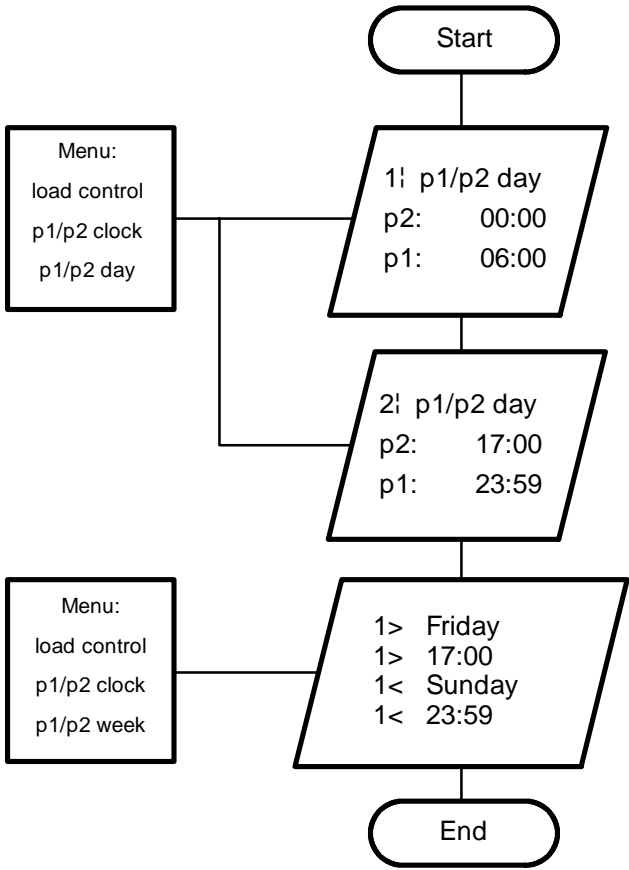

5 SIGMA CONTROL Menus

When the compressor package is switched on, details of the software are initially shown in SIGMA CONTROL's display. The software is then loaded and the main menu appears in the display.

Example of the initial display:

PN: 7.7000.0
SN: 00000000
SYS: S5: HW:
2.14 0.70 0.6

PN: part number

SN: serial number

SYS: system version

S5: operating system version

HW: hardware version

5.1 Main Menu

The main menu shows the current system pressure, the airend discharge temperature and the mode of operation.

Example:

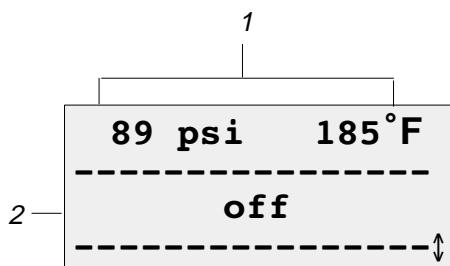

1 *Current system pressure and airend discharge temperature*

2 *Operational mode (current state)*

If the arrow down key (↓) key is pressed three times a further display level is accessed in which the total operating hours and hours on load are additionally displayed.

Example:

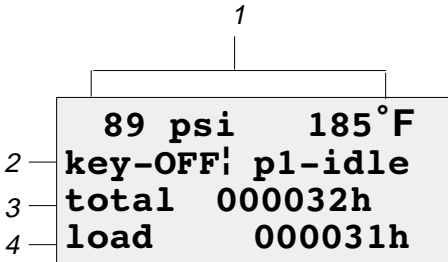

- 1 Current system pressure and airtend discharge temperature
- 2 Operational mode (current state)
- 3 Total operating hours
- 4 Hours on load

The following information can be displayed in the second line (operational messages):

e.g. key-ON ; p1-idle

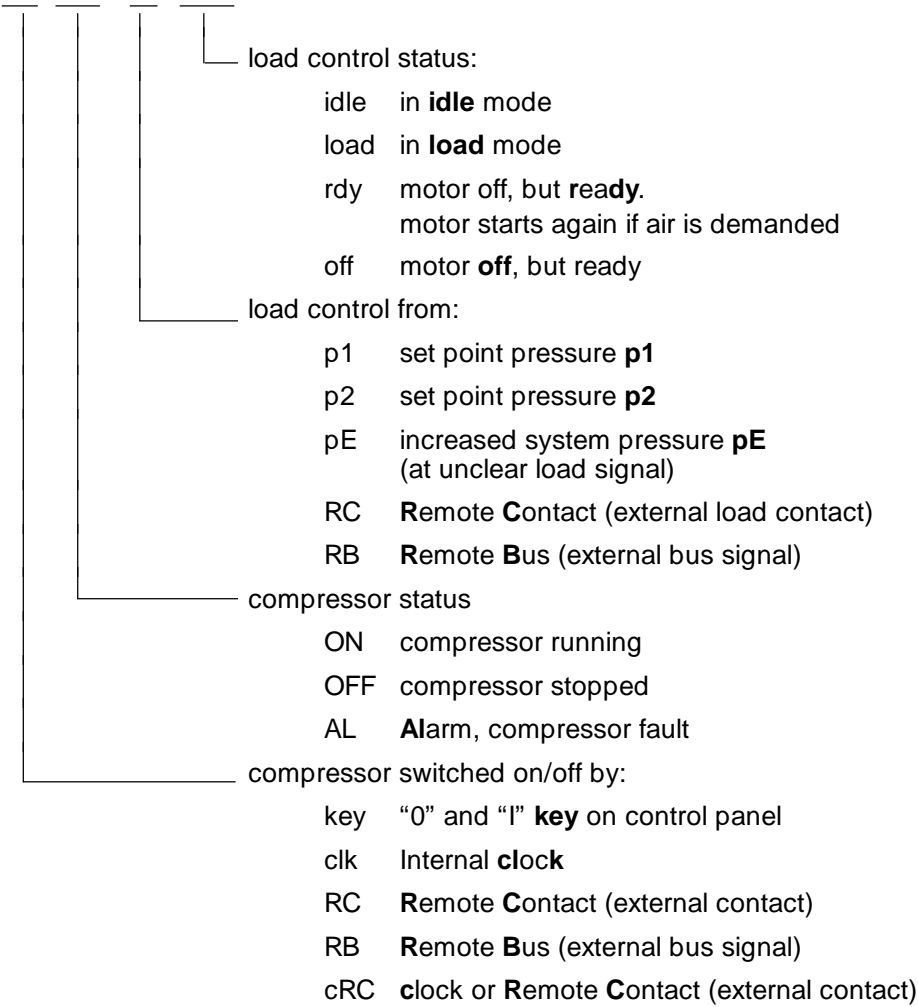

Note

Return to the main menu from all other menus with the 'esc' key.

5.2 Password Protection

When the controller is switched on, the lowest level of access (level 0) is started. An access level (level 4) is available to the customer's user. Changes to the settings in Sigma Control are allowed in level 4.

See chapter 7.1.1 for entry of the password.

Attention!

The password level automatically resets to level 0 within a period of three hours.

5.3 Display and Setup Level

If the main menu is scrolled upwards with the arrow up key (↑), all menus in the Display and Setup Level in which default values can be changed are shown. These are:

- password
- clock
- configuration
- components
- package test
- communication
- language

5.4 Display Level

If the main menu is scrolled downwards with the arrow down key (↓), the menus in the Display Level in which values can only be read are shown. These are:

- status
- analog data
- operating data
- maintenance

See following pages for an overall list of menus and submenus in the Display and Setup Level.

For an explanation of the abbreviated messages in the Display, see list of abbreviations in chapter 7.8.

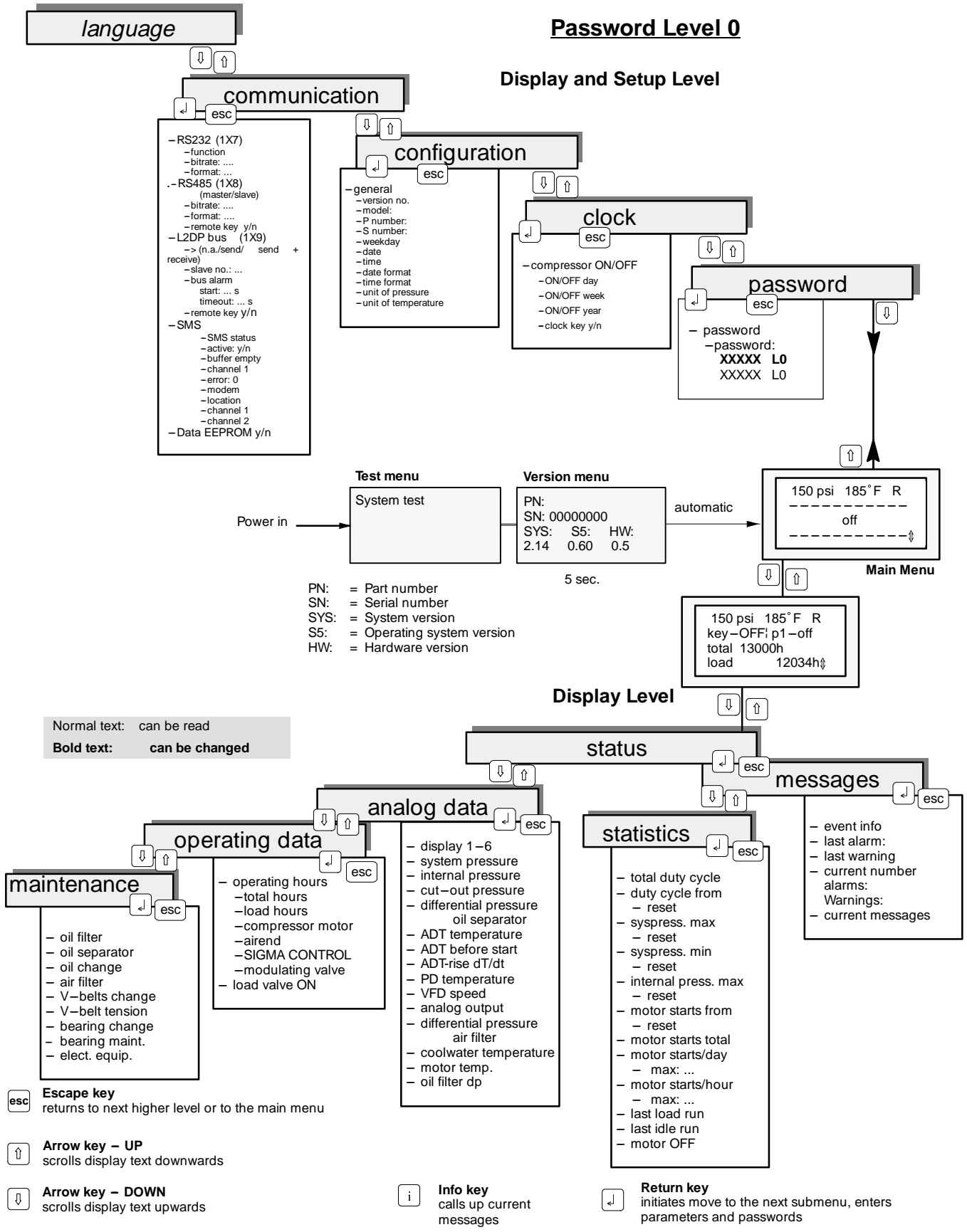

Display Level

Password Level 4

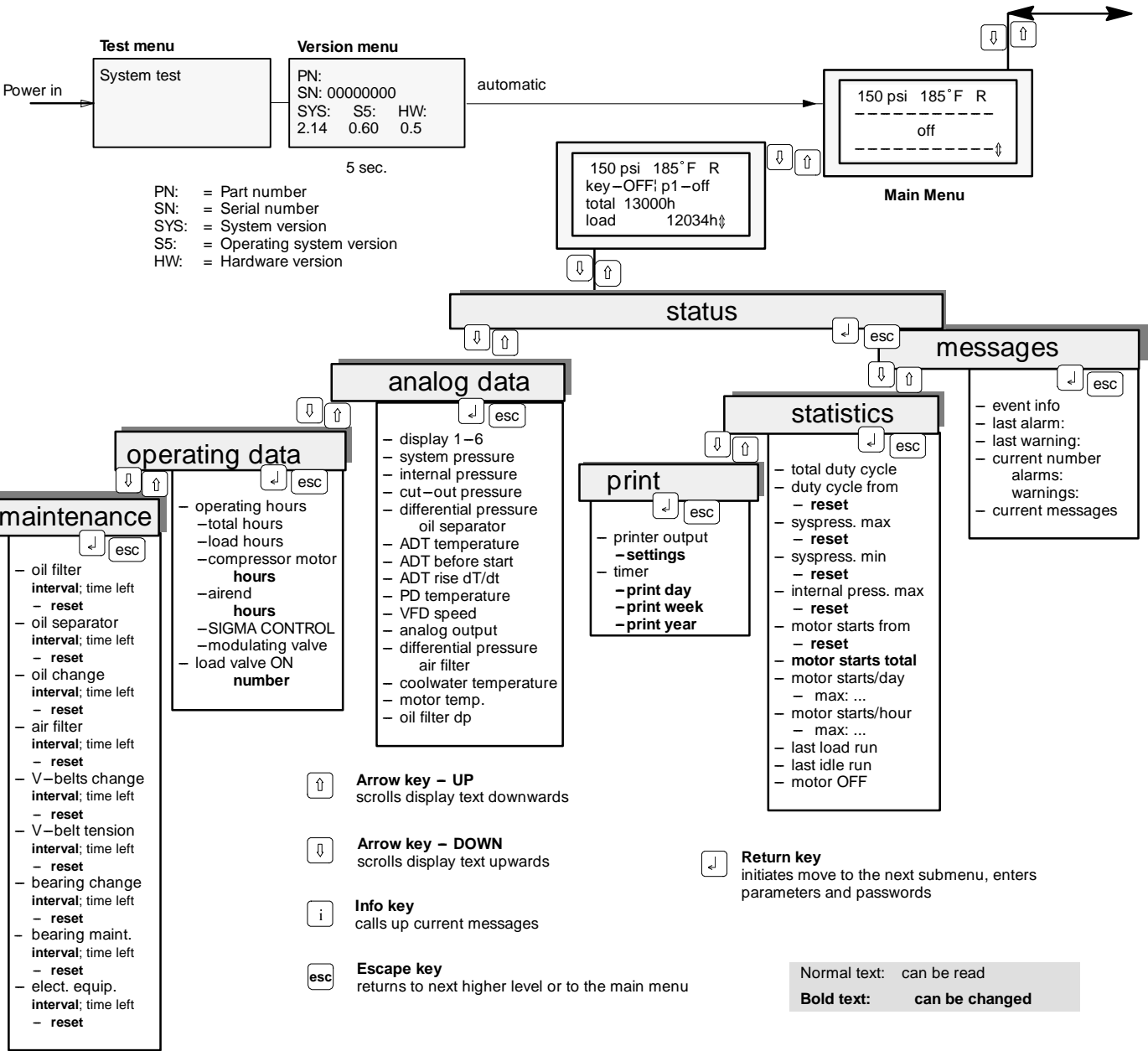

Display and Setup Level

Password Level 4

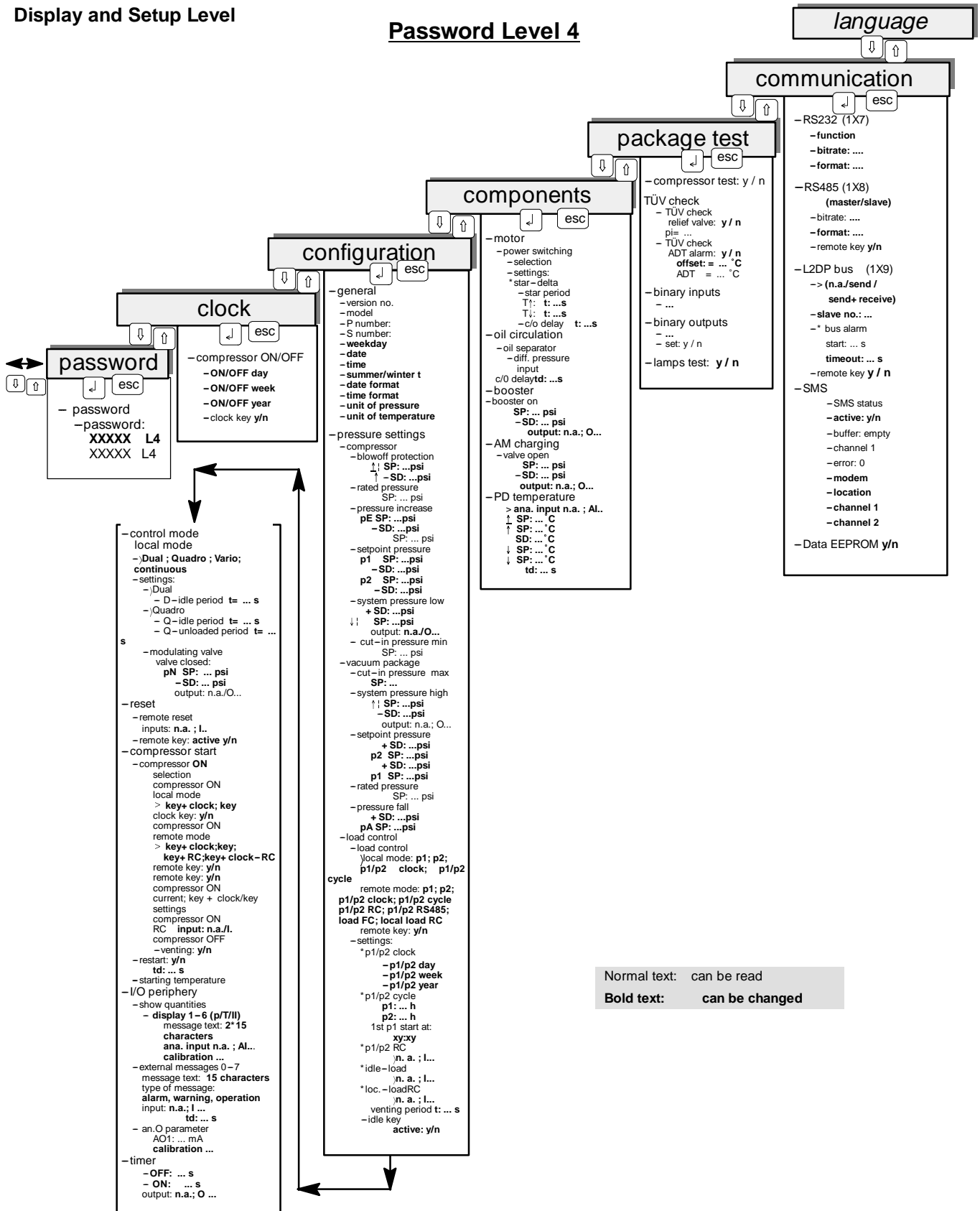

6 Display Level in SIGMA CONTROL

Status and measurement data, operational data and service intervals can be accessed in the Display Level.

Note All the following points refer to password level 4.

6.1 Status Data

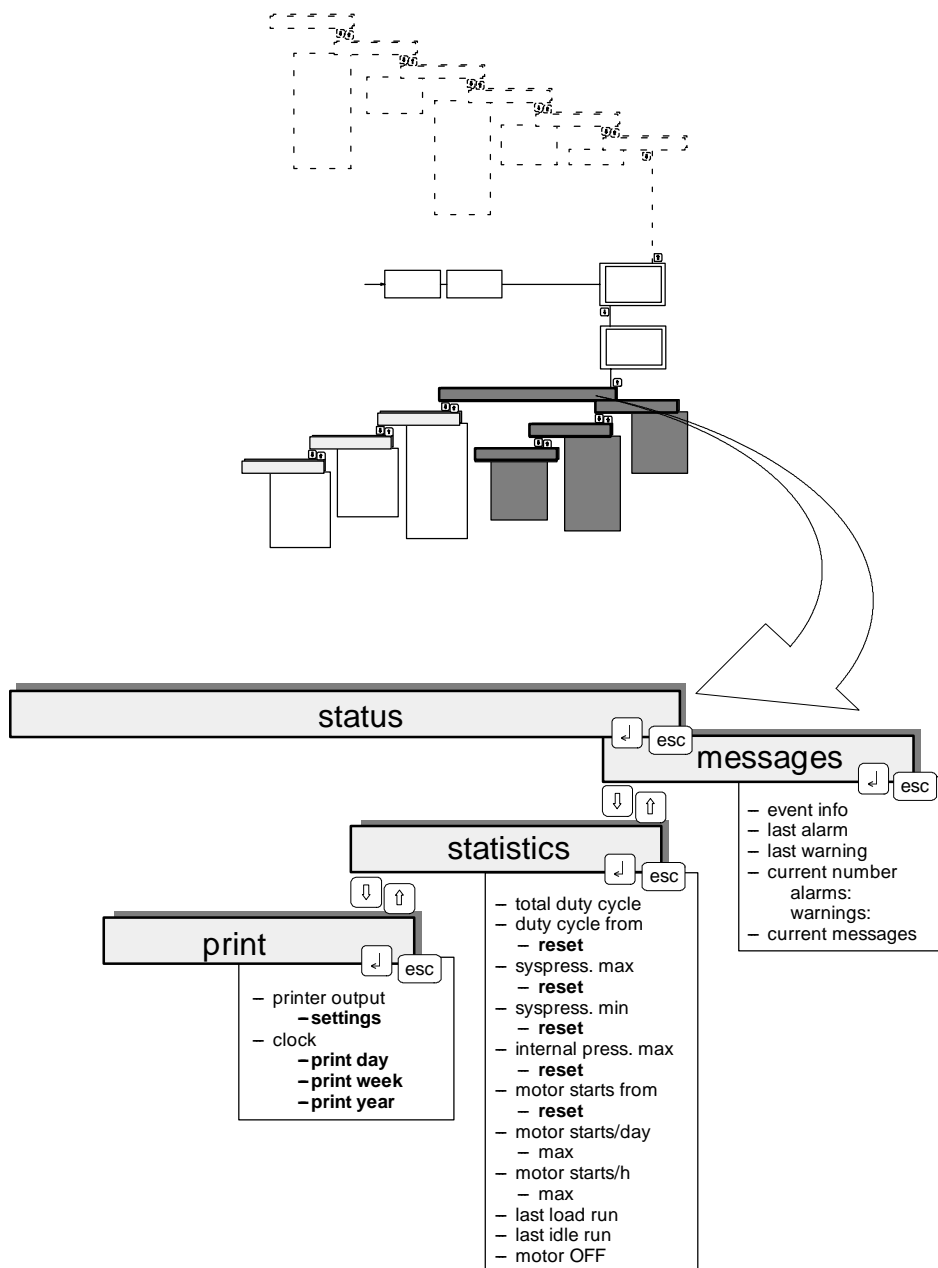

Display of status data

☞ Press the arrow key (↓) until “status” appears in the third line of the display and then press the enter key (↵).

Three further options are displayed:

- messages
- statistics
- print

6.1.1 Messages

☞ Activate the “messages” menu option by pressing the return key (↵) when “messages” appears in the third line of the display.

The submenu is divided into the following options:

- event information
The last 100 messages can be displayed. These include alarm messages and warning messages.
- last alarm
The time at which the last alarm occurred and the corresponding alarm number.
- last warning
The time at which the last warning message occurred and the corresponding message number.
- number of current alarm and warning messages.
- call-up of all current messages

Note This menu option shows all current alarms and warnings and is especially useful for faultfinding.

It can also be called up directly with the “i” key.

The following display options are possible:

Example:

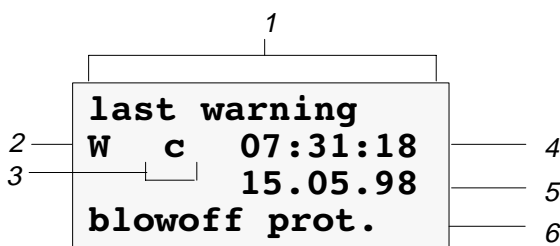

- | | | | |
|---|-------------------------------------|---|------------------------------|
| 1 | Type of display option | | |
| 2 | Type of message | W | Warning |
| | | A | Alarm |
| 3 | Message status | c | Message has come |
| | | g | Message has gone |
| | | a | Message acknowledged (reset) |
| 4 | Time of arrival of warning or alarm | | |
| 5 | Date of arrival of warning or alarm | | |
| 6 | Actual warning or alarm | | |

6.1.2 Statistics

☞ Activate the “statistics” menu by pressing the return key (↵).

The following statistical evaluations are displayed:

- total duty cycle in percent
(ratio of hours on load to total hours)
- duty cycle from a defined day onwards

If the word “reset” is in the third line of the display, it can be selected with the return key (↵) and changed to “y” with the arrow key (↑). Confirm the reset with the enter key (↵).

The actual date is entered by the reset. The duty cycle of the compressor package is recalculated from this point in time.

- Maximum system pressure

The maximum pressure evaluated since the last reset is displayed.

If the word “reset” is in the third line of the display, it can be selected with the return key (↵) and changed to “y” with the arrow up key (↑). Confirm the reset with the return key (↵).

The current value is accepted and monitoring is restarted.

- Minimum system pressure

The minimum pressure evaluated since the last reset is displayed.

If the word “reset” is in the third line of the display, it can be selected with the return key (↵) and changed to “y” with the arrow up key (↑). Confirm the reset with the return key (↵).

The current value is accepted and monitoring is restarted.

- Maximum internal pressure

The maximum pressure evaluated since the last reset is displayed.

If the word “reset” is in the third line of the display, it can be selected with the return key (↵) and changed to “y” with the arrow up key (↑). Confirm the reset with the return key (↵).

The current value is accepted and monitoring is restarted.

- Motor starts from a defined day onwards

The number of motor starts since the last reset is displayed.

If the word “reset” is in the third line of the display, it can be selected with the return key (↵) and changed to “y” with the arrow up key (↑). Confirm the reset with the return key (↵).

The current value is accepted and monitoring is restarted.

- Motor starts

The total number of motor starts is displayed and can be changed, if required. This could be the case if another drive motor is fitted.

- Motor starts per day

The number of starts during the last 24 h are displayed, together with the number of permissible starts per day.

- Motor starts per hour

The number of starts during the last 60 minutes is displayed, together with the number of permissible starts per hour.

- Last load run

The time and date on which the last changeover from load to idle occurred or on which the compressor was shut down under load is displayed.

- Last idle run
The time and date on which the last changeover from idle to load occurred or on which the compressor was shut down in idle is displayed.
- Last motor off
The time and date on which the compressor was last shut down, or was switched to standby when in idle is displayed.

The following display options are possible:

Example:

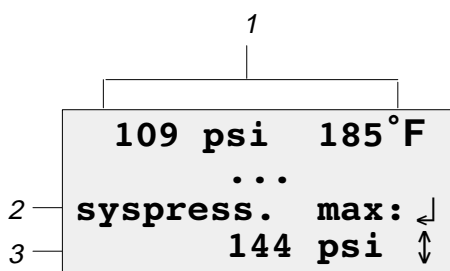

- 1 Current system pressure and airtend discharge temperature
- 2 Description of statistic
- 3 Value (percentage, minimum or maximum value)

6.1.3 Print

☞ Activate the print menu by pressing the return (↵) key.

All messages to be printed are displayed.

Example:

- new messages
- event info (history)
- clock event info
- parameters
- parameters → file

The following display options are possible:

Example:

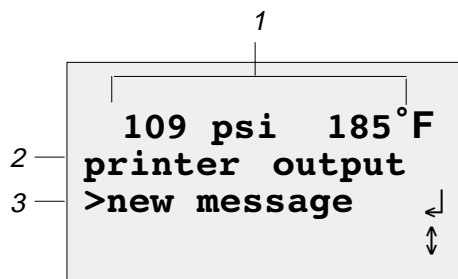

- 1 Current system pressure and airend discharge temperature
- 2 Description of status
- 3 Message to be printed

6.1.3.1 Printer clock

The printer can also be controlled with the internal clock.

☞ Press the return key (↵) twice, the following display appears.

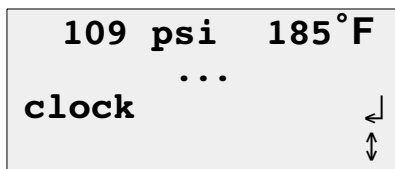

☞ Press the return key (↵) to set the clock for the printer in the following submenu.

The clock for the printer can be set up exactly the same as for the clock for compressor (see chapter 7.2).

6.2 Analog data

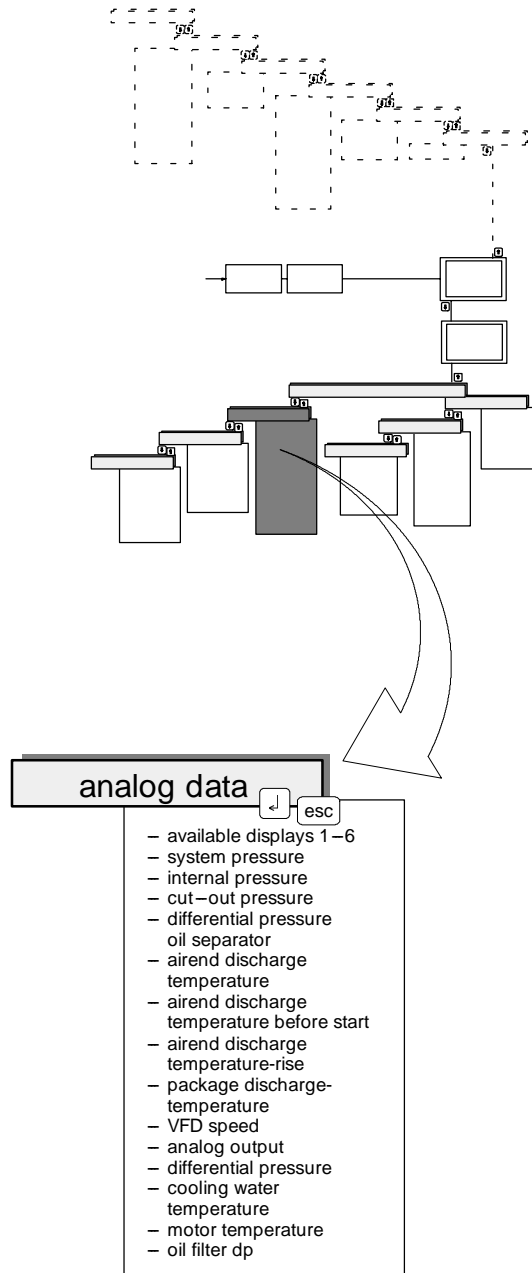

Display of analog data

- ☞ Press and hold the arrow key (↕) until “analog data” appears in the third line of the display.
- ☞ Press the return key (↵).

All analog data of the compressor package are displayed.

Example:

- current system pressure (pN)
- current internal pressure (pi)*
- current cut–out pressure (p1(2)) SP and SD
- pressure differential across oil filter (dp)*
- airoend discharge temperature (ADT)
- airoend discharge temperature before start
- airoend discharge temperature rise rate (dT/s)
- package discharge temperature (PDT)*
- variable frequency drive speed
- analog output*
- pressure differential across air filter (dp)*
- cooling water temperature*
- motor temperature*
- pressure differential across oil filter (dp)*

* optional or according to compressor model

The following display options are possible:

Example:

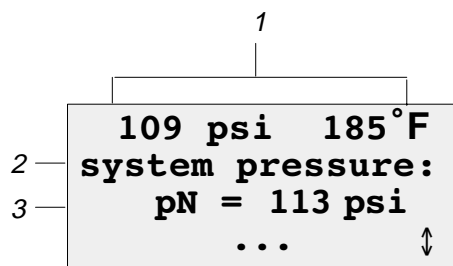

- 1 *Current system pressure and airoend discharge temperature*
- 2 *Description of measured value*
- 3 *Value*

6.3 Operating data

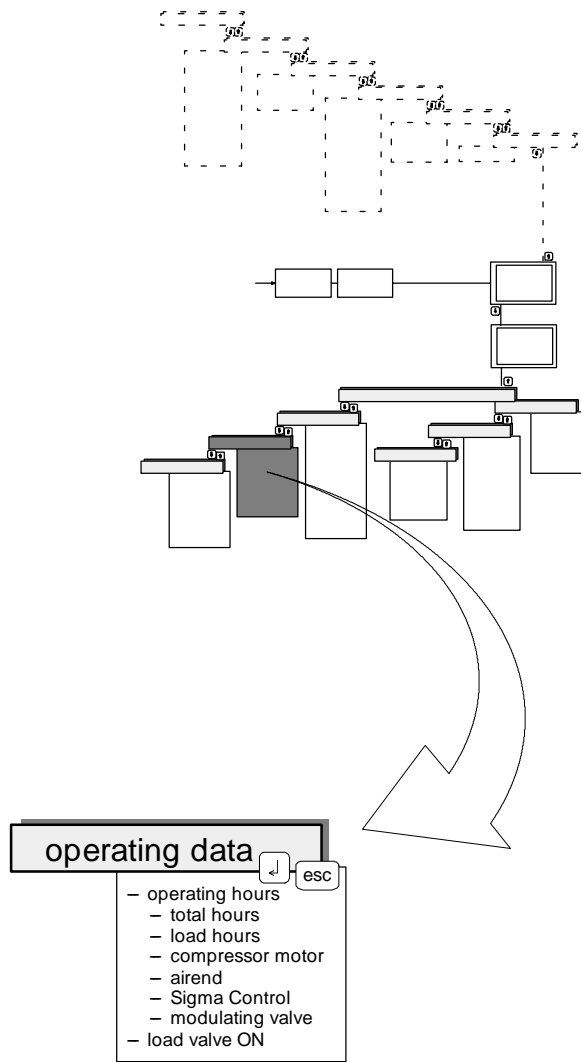

Display of operating data

- ☞ Press and hold the arrow down key (↓) until “operating data” appears in the third line of the display.
- ☞ Press the return key (↵) to display operating hours, total hours, number of motor starts and the number of operations of the load valve.
Move from one display to the next with the arrow keys (↑↓).
- ☞ Press the return key (↵) until “operating hours” appears in the third line of the display.
- ☞ Move between the different displays with the arrow keys (↑↓).

All running periods are displayed, such as

- total hours
- load hours
- motor running hours*
- airend running hours*
- Sigma Control operating hours*
- modulating valve operating hours*

* If the hours shown in the third line of the display their value can be selected with the return key (↵) and changed with the arrow keys (↑↓). Change the hours if the corresponding component has been replaced.

The following display options are possible:

Example:

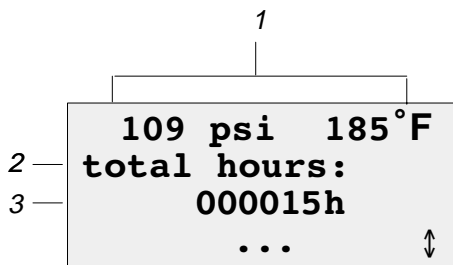

- 1 *Current system pressure and airend discharge temperature*
- 2 *Description of counter*
- 3 *Counter value*

6.4 Maintenance

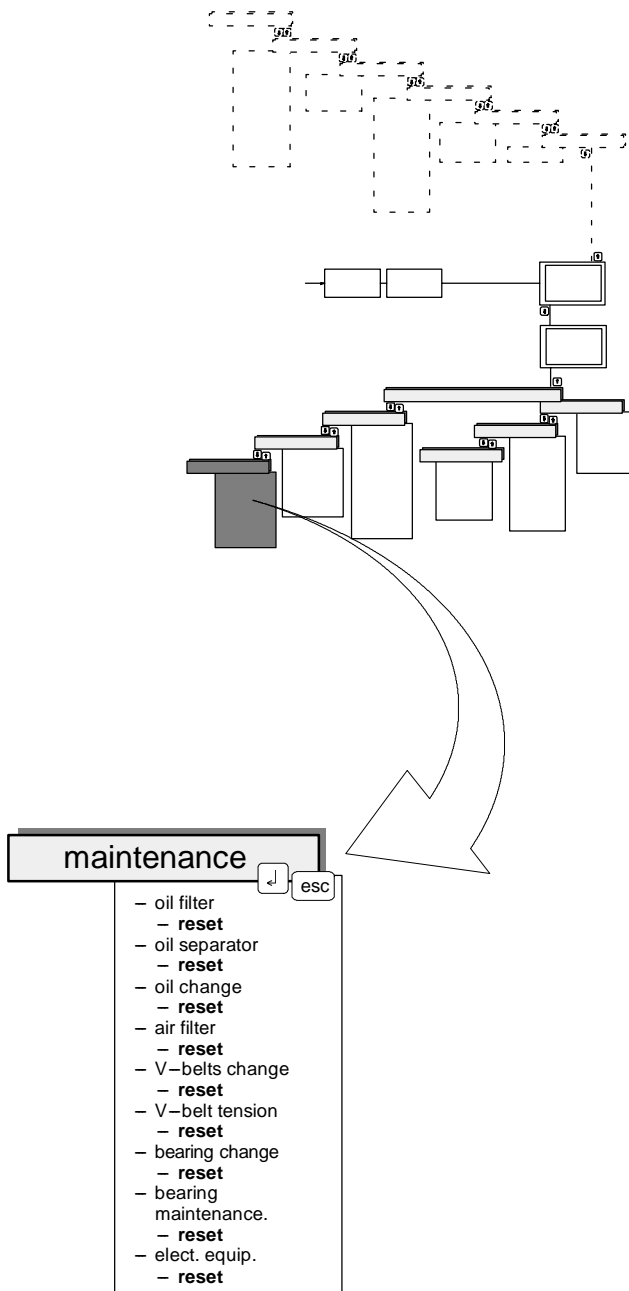

Display of maintenance hours

- ☞ Press and hold the arrow down key (↓) until “maintenance” appears in the third line of the display.
- ☞ Press the return key (↵).

All maintenance hours remaining until the next maintenance are displayed.

Example:

- oil filter
- oil separator
- oil change
- air filter
- V–belts change
- V–belt tension
- bearing change
- bearing maintenance
- elect. equip.

The following display options are possible:

Example:

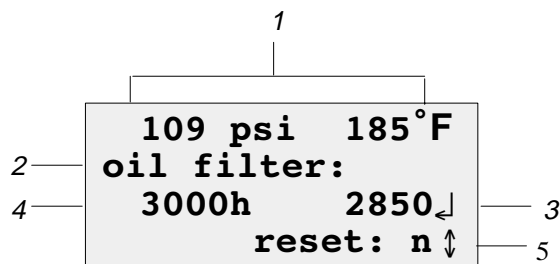

- 1 Current system pressure and airtend discharge temperature
- 2 Description of maintenance counter
- 3 Remaining hours to next maintenance
(remaining time – countdown)
- 4 Default maintenance interval
- 5 Reset of maintenance interval

6.4.1 Setting/resetting the maintenance interval counter

Attention!

When the maintenance is complete the remaining interval (3) must be reset to the default interval (4).

Note

Password level 4 access is required to carry out changes to the maintenance interval counters.

☞ Activate password level 4 (see chapter 7.1.1.)

- **Resetting the maintenance interval counter**

The remaining hours in the corresponding maintenance interval counter can be individually reset.

☞ Press and hold the arrow down key (↓) until “reset” appears in the third line of the display.

Example:

```
109 psi 185°F
3000h 50h
reset n ↵
... ↕
```

☞ Press the return key (↵), a flashing cursor appears below the “n”.

☞ Change the reset display from “n” to “y” with the arrow up key (↑).

☞ Confirm with the return key (↵). The counter resets to the default maintenance interval. At the same time the reset display changes from “y” to “n”.

- **Setting the maintenance interval**

☞ Press and hold the arrow down key (↓) until the hours display for the required maintenance interval appears in the third line of the display.

Example:

```
109 psi 185°F
oil filter
3600h 2735h ↵
Reset: n ↕
```

☞ Press the return key (↵), a flashing cursor appears below the maintenance interval.

☞ The maintenance interval can be increased with the arrow up key (↑) and reduced with the arrow down key (↓).

☞ Enter the maintenance interval setting with the return key (↵).

☞ Return to the main menu with the “esc” key.

7 Display and Setup Level

In the Display and Setup Level the settings for the password, clock, configuration, package test and the interfaces are displayed.

The settings can be individually adapted at this level.

Note All the following points refer to password level 4.

7.1 Password

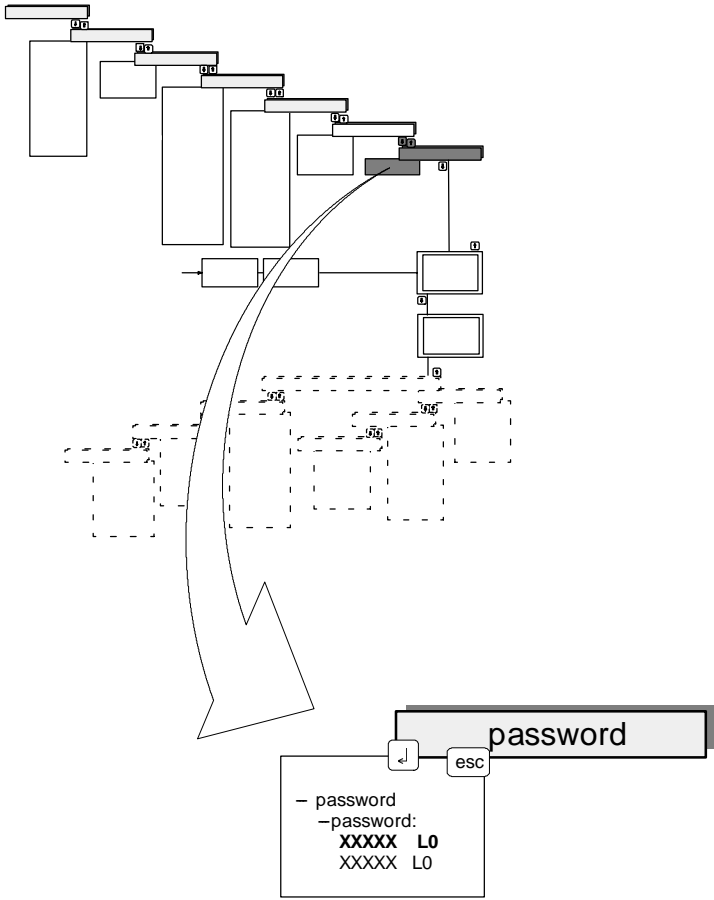

7.1.1 Enter password

(main menu → password)

- ☞ In the main menu, press and hold the arrow down key (⇓) until “password” appears in the third line of the display.
- ☞ Press the return key (↵).

The following display appears:

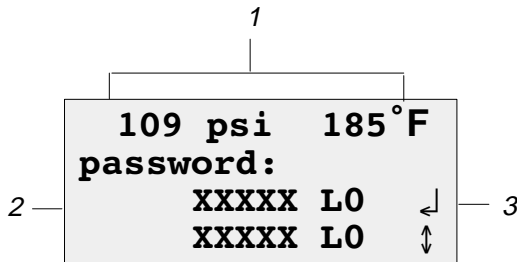

- 1 Current system pressure and airtend discharge temperature
- 2 Description of step to be taken
- 3 Activation of above step

- ☞ Press the return key (↵).

The cursor flashes in the first character of the password (XXXXX).

- ☞ Scroll through the character set with the arrow keys (⇓⇑) until the desired character appears.
- ☞ Press the return key (↵) to confirm the selection and the cursor moves to the next character in the password.

Repeat the procedure for the remaining characters in the password.

The activated password level is shown when the last character is entered.

The following passwords are entered in the controller on delivery:

<i>Level</i>	<i>Password</i>
0	00000
4	12EXP

7.2 Clock

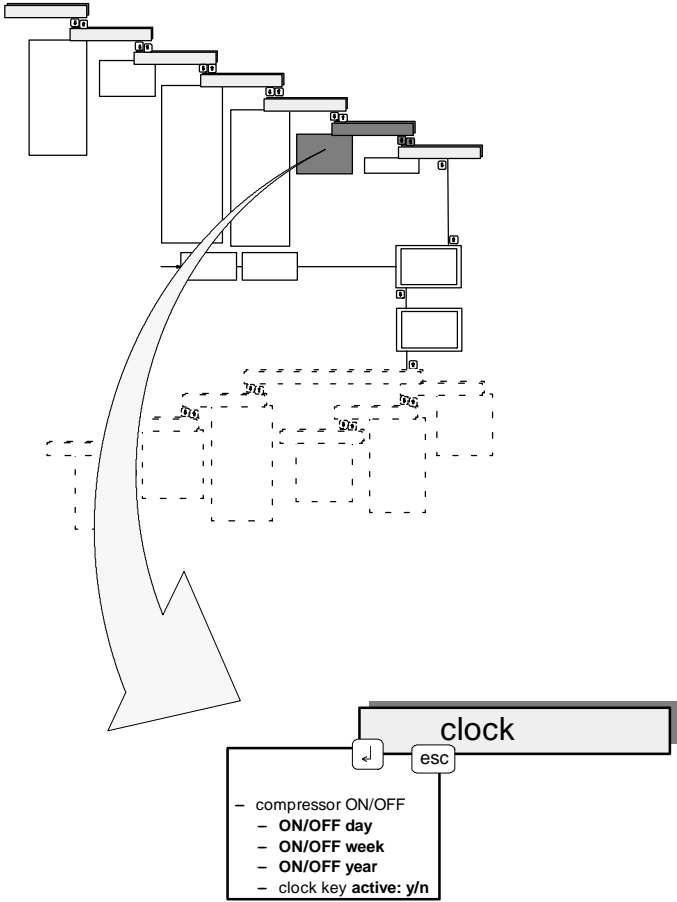

Display and set up of the clock

(main menu → clock)

- ☞ In the main menu, press and hold the arrow up key (↑) until “clock” appears in the third line of the display.
- ☞ Press the return key (↵).

The clock can be programmed in this submenu:

- compressor ON/OFF

The following display options are possible:

Example:

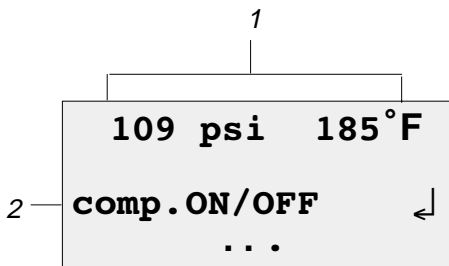

- 1 Current system pressure and airtend discharge temperature
- 2 Display of clock channel

- ☞ Press the return key (↵) to open the clock settings submenu.

Example “compressor ON/OFF” (clock channel for the compressor package):

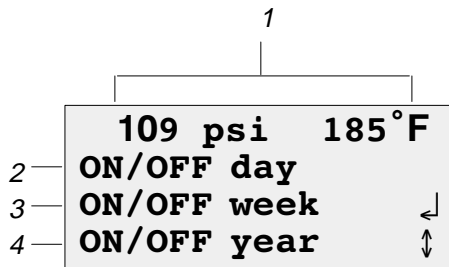

- 1 Current system pressure and airtend discharge temperature
- 2 Daily schedule
- 3 Weekly schedule
- 4 Yearly schedule

- ☞ Scroll the menu options up and down with the arrow keys (↑↓).
- ☞ Scroll the schedule to be changed to the third line and activate with the return key (↵).

Example: daily compressor schedule (ON/OFF day)

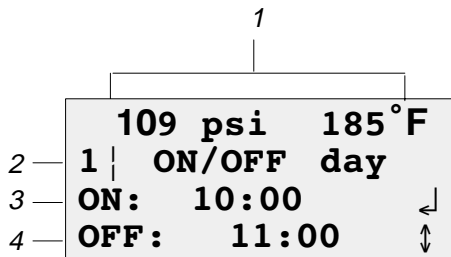

- 1 Current system pressure and airtend discharge temperature
- 2 First ON/OFF schedule (period)
- 3 Cut-in time (ON switching point) of the compressor package in hours and minutes
- 4 Cut-out time (OFF switching point) of the compressor package in hours and minutes

☞ The cut-in and cut-out times of the compressor package can be changed by pressing the return key (↵).

7.2.1 General description of the clock

The compressor package can be controlled from the clock by pressing the clock key. This allows the fluctuating air demand to be time controlled.

Four time periods within a day, four time periods within a week and four time periods within a year can be programmed.

A **yearly schedule** (month – day of the month – hour – minute), a **weekly schedule** (weekday – hour – minute) and a **daily schedule** (hour – minute) is available to the user for entry of switching points. The switching points in the yearly and weekly schedules are entered as periods (with start and end) and the switching points in the daily schedule are entered as points in time. The yearly schedule has the highest and the daily schedule the lowest priority. The last option in each menu is the delete function, with which all entries in a corresponding schedule can be deleted.

7.2.1.1 The daily schedule

The compressor runtimes are entered in the daily schedule.

Four switching points are available.

The compressor package can be switched on and off automatically four times per day.

The programmed operational state of a switching point remains active until it is overridden by the operational state of a subsequent switching point or if the weekly/yearly schedule activates.

Note The daily schedule has the lowest and the yearly schedule the highest priority.

Switching points in the weekly schedule have priority over switching points in the daily schedule.

Daily switching point restrictions, such as are necessary for the weekend, are entered in the weekly schedule.

The following conditions must be fulfilled:

- The periods entered must contain all relevant information. (start time, end time)

7.2.1.2 The weekly schedule

All periods that are repeated during a weekly cycle are entered in the weekly schedule. If the overriding yearly schedule is not active, a current period in the weekly schedule can be activated. The following conditions must be fulfilled:

- The periods entered must contain all information required (start weekday, start time, end weekday, end time, required operational state).

7.2.1.3 The yearly schedule

An interruption of the cyclic daily schedule may be required if, for example, a public holiday occurs on a working day, or if a different schedule is required during holiday periods.

These periods can be started and ended at any convenient date and time. If no further period is scheduled to follow the end of a period, the program returns to the weekly schedule.

As it is not possible to enter the year in the periods they are not unique, but repeat annually if not deleted.

The following conditions must be fulfilled to enable a correctly scheduled sequence of programmed periods:

- The periods entered must contain all relevant information.
(start date, start time, end date, end time, required operational state).

Attention!

When the “clock” key is pressed (3, see chapter 4.3.1) only the channel command (compressor channel) from the clock is used to control the compressor package.

The clock function itself is not influenced, that is, the clock runs continuously in the background.

Example 1:

It is intended to run a compressor from 05:30 to 12:00 and from 13:00 to 21:10 daily. It is shut down at weekends from 14:00 Fridays to 05:30 Mondays, during company holidays from 11 July to 26 July, and over the New Year from 12:00 on December 24 to 05:30 on January 2.

Menu: clock – compressor ON/OFF – ON/OFF day:

- **1 | ON/OFF day**
ON: 05:30
OFF: 12:00
- **2 | ON/OFF day**
ON: 13:00
OFF: 21:10

Enter "0" for day 3 and 4 switching points.

Menu: clock – compressor ON/OFF – ON/OFF week:

- **1 | ON/OFF week**
1→ Friday
14:00
1← Sunday
23:59
1: comp. OFF

Enter "0" for week 2 to week 4 switching points.

Menu: clock – compressor ON/OFF – ON/OFF year:

- **1 | ON/OFF year**
1→ 11.07.
00:00
1← 26.07.
23:59
1: comp. OFF
- **2 | ON/OFF year**
2→ 24.12.
12:00
2← 31.12.
23:59
2: comp. OFF

- **3 | ON/OFF year**
3→ 01.01.
00:00
3← 02.01.
05:30
3: comp. OFF

Enter "0" for year switching point 4.

Example 2:

A compressor is required from 6:00 Monday until 22.00 Saturday because of four–shift working in production.

Menu: clock – compressor ON/OFF – ON/OFF week:

- 1 | ON/OFF week
1→ Monday
06:00
1← Saturday
22:00
1: comp. ON

Note “>” period start
“<” period end

Note All settings in the ‘compressor ON/OFF’ menu are active only after the clock key has been pressed.

Note The clock key is inactive on delivery to prevent operator error. It can be enabled in the ‘clock – compressor ON/OFF menu’.

7.2.1.4 Clock key

Menu: clock – compressor ON/OFF – clock key

The clock key (⌚) on Sigma Control can be deactivated to prevent clock functions being switched off.

☞ Press the arrow keys (↑↓) until the following display appears:

```
109 psi 185°F
clock key: n ↵
ON/OFF day ↑
```

☞ Press the return key (↵).

☞ Change the entry from “act.: y” to “act.: n” with the arrow keys (↑↓).

☞ Confirm with the return key (↵).

☞ Return to the main menu with the “esc” key.

7.3 Configuration

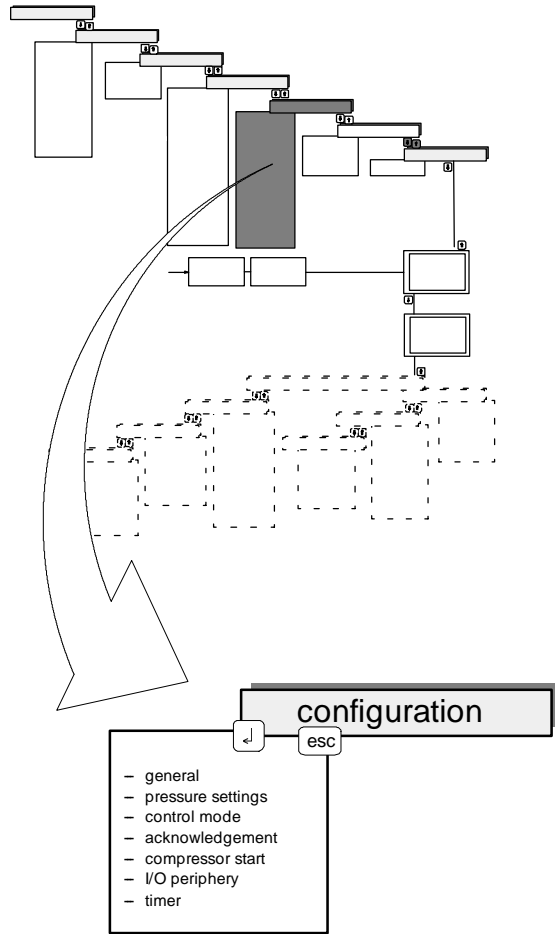

Display and set up of the configuration

(main menu → configuration)

- ☞ In the main menu, press and hold the arrow up key (↑) until “configuration” appears in the third line of the display.
- ☞ Press the return key (↵).

All settings affecting the configuration can be displayed and changed in password level 4.

The following display options are possible:

- general
- pressure settings
- control mode
- acknowledgement (reset)
- compressor start
- I/O periphery
- timer

Example:

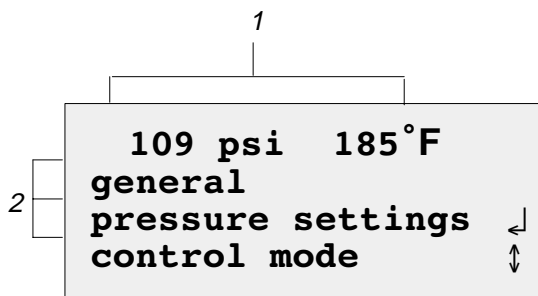

- 1 Current system pressure and airtend discharge temperature
- 2 Display of the various submenus

- ☞ Scroll between the individual entries with the arrow keys (↑↓).
- ☞ Scroll the desired menu option to the third line and activate with the return key (↵).

7.3.1 General

(main menu → configuration → general)

- ☞ Press and hold the arrow keys (↑↓) until “general” appears in the third line of the display.
- ☞ Press the return key (↵).

The following values are shown and can be changed, if required:

- version no.
- model
- PN: (part number)
- SN: (serial number)
- weekday
 - ☞ Press and hold the arrow keys (↑↓) until “weekday” appears in the second line of the display. The default weekday is displayed.
 - ☞ Press the return key (↵).
 - ☞ Use the arrow keys (↑↓) to select the current day of the week.
 - ☞ Confirm with the return key (↵).
 - ☞ Return to the main menu with the “esc” key.

- date
 - ☞ Press and hold the arrow keys (↑↓) until “date” appears in the second line of the display. The default date is displayed.
 - ☞ Press the return key (↵).
 - ☞ Use the arrow keys (↑↓) to select the current date.
 - ☞ Confirm with the return key (↵).Repeat the above procedure for the month and year.
 - ☞ Return to the main menu with the “esc” key.
- time setting
 - ☞ Press and hold the arrow keys (↑↓) until “time” appears in the second line of the display.
 - ☞ Press the return key (↵).
 - ☞ Use the arrow keys (↑↓) to select the current hour.
 - ☞ Confirm with the return key (↵).Repeat the above procedure for minutes and seconds.
 - ☞ Return to the main menu with the “esc” key.
- summer/winter time
 - ☞ Press and hold the arrow keys (↑↓) until “summer/winter t” appears in the second line of the display.
 - ☞ Press the return key (↵).
 - start of summer time:
 - ☞ Press and hold the arrow keys (↑↓) until “summertime” appears in the second line of the display.
 - ☞ Press the return key (↵). A flashing cursor appears below the day value.
 - ☞ Select the date and month with the arrow keys (↑↓) and confirm each setting with the return key (↵).
 - ☞ Press the arrow down key (↓) until the time appears in the third line of the display. Press the return key (↵).
 - ☞ Select the hours and minutes with the arrow keys (↑↓) and confirm each setting with the return key (↵).
 - start of winter time:
 - ☞ Press and hold the arrow keys (↑↓) until “wintertime” appears in the second line of the display.
 - ☞ Press the return key (↵). A flashing cursor appears below the day value.
 - ☞ Select the date and month with the arrow keys (↑↓) and confirm each setting with the return key (↵).
 - ☞ Press the arrow down key (↓) until the time appears in the third line of the display. Press the return key (↵).
 - ☞ Select the hours and minutes with the arrow keys (↑↓) and confirm each setting with the return key (↵).
 - activating the time changeover:
 - ☞ Press and hold the arrow keys (↑↓) until “time changeover” appears in the second line of the display.
 - ☞ Press the return key (↵).
 - ☞ Change the entry from “n” to “y” with the arrow keys (↑↓) and activate with the return key (↵).

- data format (TT.MM.JJ)

- ☞ Press and hold the arrow keys (↑↓) until “date format” appears in the second line of the display.

The currently set date format is shown in the third line of the display.

- ☞ Press the return key (↵).

The cursor flashes below the date format.

- ☞ Use the arrow keys (↑↓) to select the required date format.

Example:

DD.MM.YY	30.08.98
YY-MM-DD	98-08-30
MM/DD/YY	08/30/98

D stands for day, M for month, and Y for year.

- ☞ Confirm with the return key (↵).

- time format (hh:mm:ss)

- ☞ Press and hold the arrow keys (↑↓) until “time format” appears in the second line of the display.

- ☞ Press the return key (↵).

The cursor flashes below the time format.

- ☞ Use the arrow keys (↑↓) to select the required time format.

Example:

hh:mm:ss	08:29:43
hh:mm	08:29
hh:mm:ss AM/PM	08:29:43 AM
hh:mm AM/PM	08:29 AM

h stands for hours, m for minutes, s for seconds, AM for forenoon and PM for afternoon.

- ☞ Confirm with the return key (↵).

- unit of pressure (bar, hPa, MPa, psi, at, “Hg)

- ☞ Press and hold the arrow keys (↑↓) until “unit of press.” appears in the second line of the display.

The unit of pressure is displayed in the third line.

- ☞ Press the return key (↵).

A flashing cursor appears below the unit of pressure.

- ☞ Use the arrow keys (↑↓) to select the required unit of pressure.

Example:

bar	
hPa	hectopascal
MPa	megapascal
psi	pressure per square inch
at	atmospheric gauge pressure
“Hg	inches of mercury column

- ☞ Confirm with the return key (↵).

- unit of temperature
 - ☞ Press and hold the arrow keys (↑↓) until “unit of temp.” appears in the second line of the display.

The unit of temperature is displayed in the third line.

- ☞ Press the return key (↵) and a flashing cursor appears below the unit of temperature.
- ☞ Use the arrow keys (↑↓) to select the required unit of temperature.

Example:

20 °C	degrees Celsius
68 °F	degrees Fahrenheit
293 K	degrees Kelvin

- ☞ Confirm the selection with the return key (↵).

7.3.2 Pressure settings

(main menu → configuration → pressure settings)

- ☞ Press and hold the arrow keys (↑↓) until “pressure settings” appears in the third line of the display.
- ☞ Press the return key (↵).

The pressure settings menu has three options:

- compressor
- vacuum package
- load control

7.3.2.1 Compressor configuration

(main menu → configuration → pressure settings → compressor)

Pressure parameters important for the compressor are displayed and set in the following submenu.

- ☞ Press the return key (↵) to enter the submenus.

7.3.2.1.1 System pressure

(main menu → configuration → pressure settings → compressor → system pressure)

- ☞ Press and hold the arrow keys (↑↓) until “system pressure” appears in the third line of the display.
- ☞ Enter the submenu with the return key (↵).

This submenu is divided into the following options:

- blowoff prot.

Two switching points (SP) are displayed:

↑ | stands for overpressure alarm
↑ | stands for overpressure warning

These values are installed at the factory and can only be changed by an authorised KAESER agent.

- nominal pressure

The compressor is designed for this end pressure. It also represents the maximum possible system setpoint pressure.

This value is installed at the factory and can only be changed by an authorised KAESER agent.

- setpoint pressure

The two pressure parameters p1 and p2 at which the compressor package can be run, i.e. the upper cut-out point together with its switching differential (SD) in each case are displayed and can be changed here.

Setting up a parameter:

☞ Scroll the required parameter into the third line of the display with the arrow keys (↑↓).

☞ Press the return key (↵).

☞ Set the required value with the arrow keys (↑↓) and confirm with the return key (↵).

- system pressure low

The parameters for switching differential (SD) and the switching point (SP) for the low pressure warning message are displayed and can be set in this menu option.

Setting a parameter:

☞ Scroll the required parameter into the third line of the display with the arrow keys (↑↓).

☞ Press the return key (↵).

☞ Set the required value with the arrow keys (↑↓) and confirm with the return key (↵).

- minimum cut-in pressure (cutin press min):

The minimum cut-in pressure is a design characteristic of the airend.

Note

Economical production of compressed air is only possible above this pressure.

It is regarded as the system pressure lower limit minus the system pressure switching differential.

☞ Scroll the parameter to be set into the third line of the display.

☞ Press the return key (↵).

A cursor appears below the pressure value.

☞ Set the required value with the arrow keys (↑↓) and confirm with the return key (↵).

This value is installed at the factory and can only be changed by an authorised KAESER agent.

- pressure increase

(main menu → configuration → pressure settings → compressor → pressure increase)

This value is added to the nominal package pressure during external load control and serves as the upper safety limit should the external controller malfunction.

☞ Press and hold the arrow keys (↑↓) until "press. increase" appears in the third line of the display.

☞ Press the return key (↵).

The currently set value for the pressure increase pE appears in the third line of the display.

☞ Press the return key (↵).

☞ Set the required value with the arrow keys (↑↓) and confirm with the return key (↵).

The same applies to the switching differential –SD.

☞ Return to the main menu with the "esc" key.

7.3.2.2 Vacuum package

(main menu → configuration → pressure settings → vacuum package)

- ☞ Keep pressing the arrow keys (↑↓) in the pressure settings submenu option until “vacuum package” appears in the third line of the display and then press the return key (↵).

Pressure parameters important for the vacuum package are displayed and set in the following submenus.

- ☞ Press the return key (↵) to enter the submenus.

7.3.2.2.1 System pressure of the vacuum package

(main menu → configuration → pressure settings → vacuum package)

- ☞ Press and hold the arrow keys (↑↓) until “vacuum package” appears in the third line of the display.
- ☞ Press the return key (↵).

This submenu is divided into the following options:

- cut-in pressure max
- system pressure high
- setpoint pressure
- nominal pressure
- pressure fall
- maximum cut-in pressure (cutin press max)
 - ☞ Scroll the parameter to be set into the third line of the display with the arrow keys (↑↓).
 - ☞ Press the return key (↵).
 - A flashing cursor appears below the pressure value.
 - ☞ Set the required value with the arrow keys (↑↓) and confirm with the return key (↵).
- system pressure high
 - The parameters for switching differential (SD) and the switching point (SP) for the high pressure warning message are displayed and can be set in this menu option.
 - Also the output used for the warning is shown.
 - Setting a parameter:
 - ☞ Scroll the parameter to be set into the third line of the display with the arrow keys (↑↓).
 - ☞ Press the return key (↵).
 - ☞ Set the required value with the arrow keys (↑↓) and confirm with the return key (↵).
- setpoint pressure
 - The two pressure parameters p1 and p2, i.e., the lower cut-out point together with its switching differential (SD) in each case, are displayed here.
 - Setting a parameter:
 - ☞ Scroll the parameter to be set into the third line of the display with the arrow keys (↑↓).
 - ☞ Press the return key (↵).
 - ☞ Set the required value with the arrow keys (↑↓) and confirm with the return key (↵).
- nominal pressure
 - The vacuum package is designed for this end pressure. It also represents the minimum possible system setpoint pressure.
 - This value is installed at the factory and can only be changed by an authorised KAESER agent.

- pressure fall pE

(main menu → configuration → pressure settings → vacuum package)

When external load control is activated this value is subtracted from the minimum rated package pressure. It serves as the lower safety limit should the external controller malfunction.

☞ Keep pressing the arrow keys (↑↓) until “pressure fall” appears in the third line of the display and then confirm with the return key (↵).

☞ The pressure fall pE setting is shown here.

☞ Press the return key (↵) to set the pressure fall parameter.

The cursor appears below the pressure fall value.

☞ Set the required value with the arrow keys (↑↓) and confirm with the return key (↵).

☞ Return to the main menu with the “esc” key.

Set the switching differential using precisely the same procedure.

7.3.2.3 Load control

(main menu → configuration → pressure settings → load control)

☞ Keep pressing the arrow keys (↑↓) in the “pressure settings” submenu option until “load control” appears in the third line of the display and then press the return key (↵).

- Selecting load control

The method of control for the compressor package is selected here.

With this function a changeover can be made between an external master controller (such as SAM or MVS) and the internal pressure parameters in SIGMA CONTROL.

Note

If SIGMA CONTROL is interfaced to a master controller via the Profibus then no settings have to be made. The bus master (master controller) takes over remote control automatically.

The following modes are available:

a) local mode from setpoint pressures p1 or p2

b) remote mode p1/p2 from a remote contact (RC)

- a) If the compressor is not controlled externally it defaults to the internal controller, SIGMA CONTROL.

Here, it is possible to keep to p1 or p2 permanently, to switch them with the clock or to cycle them periodically.

☞ Scroll with the arrow keys (↑↓) until “local mode” appears in the second line of the display.

☞ Press the return key (↵). A flashing cursor appears below the operating mode.

☞ Set the required mode with the arrow keys (↑↓) and confirm with the return key (↵).

- b) If the compressor package is to be controlled externally it must be set to remote mode.

In this option, priority can be given to either setpoint pressure p1 or p2, and the medium (clock, timer, ...) controlling the changeover between p1 and p2 can be selected.

☞ Scroll with the arrow keys (↑↓) until “remote mode” appears in the second line of the display.

☞ Press the return key (↵).

A flashing cursor appears below the operating mode.

☞ Set the required mode with the arrow keys (↑↓).

- Example:
- setpoint pressure p1
 - setpoint pressure p2
 - p1/p2 clock
 - p1/p2 cycle
 - p1/p2 remote contact
 - p1/p2 RS485
 - load remote contact
 - local-load remote contact

☞ Confirm with the return key (↵).

Note If the compressor package is to be controlled externally, activate the remote key (↗).

- ☞ Scroll with the arrow keys (↑↓) until “remote key y/n” appears in the third line of the display.
- ☞ Press the return key (↵).
A flashing line appears below the “y” or “n”.
- ☞ Set the required mode with the arrow keys (↑↓).
- ☞ Confirm with the return key (↵).

The current load control mode selection is displayed

- Load control settings
- ☞ Press and hold the arrow keys (↑↓) until “settings” appears.

If the compressor package is switched between p1 and p2 setpoint pressures from a remote contact the input address is shown here.

Changeover between p1 and p2 from the internal clock:

If the compressor package is to be run using two different pressures (p1 and p2), the switching points for both pressures can be set in this menu option. This is required for shift working, for example.

- ☞ Press the return key (↵) when “p1/p2” appears in the third line of the display.

The following display appears:

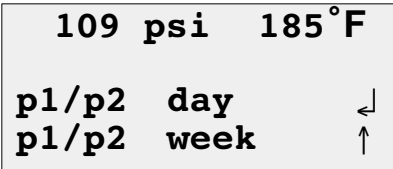

- ☞ The procedure for setting up the day, week and year schedules is exactly the same as for the clock.
- ☞ Press the return key (↵) when the parameter to be set appears in the third line of the display.
A flashing cursor appears below the time.
- ☞ Press the return key (↵) when “p1/p2 day” appears in the third line of the display.

Note Four switching points are available.

The following display appears:

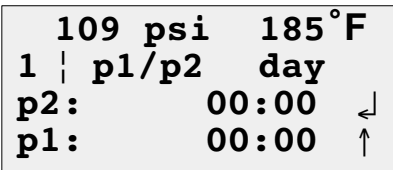

- ☞ Press the return key (↵) when the parameter to be set appears in the third line of the display.

A flashing cursor appears below the time.

- ☞ Set the hour with the arrow keys (↑↓).
- ☞ Press the return key (↵), the cursor jumps to the minutes display.
- ☞ Set the minutes with the arrow keys (↑↓).

From this switching point onwards the compressor package runs at the pressure displayed before this point in time.

- ☞ Press the return key (↵) to enter the new switching points.
- Changeover between p1 and p2 from the internal timer.

The cycle periods can be preset if the compressor package is switched by a timer between set-point pressures p1 and p2.

- ☞ Press the arrow down key (↓) until “p1: ..h” appears in the third line of the display.
- ☞ Press the return key (↵).

A flashing cursor appears below the hours.

- ☞ Set the hours with the arrow keys (↑↓).
- ☞ Confirm with the return key (↵).
- ☞ Press the arrow down key (↓) until “p2: ..h” appears in the third line of the display.
- ☞ Press the return key (↵).

A flashing cursor appears below the hours.

- ☞ Set the hours with the arrow keys (↑↓).
- ☞ Confirm with the return key (↵).

Under timer control the start of the period must be preset.

- ☞ Press the arrow down key (↓) until “> 1.Start p1 at: ..h” appears in the third line of the display.
- ☞ Press the return key (↵).

The cursor appears below the colon.

- ☞ Select either setpoint pressure p1 or p2 with the arrow keys (↑↓).
- ☞ Confirm with the return key (↵).
- ☞ Press the arrow keys (↑↓) until the time below “> 1.Start p1 at: ..h” appears in the third line of the display.
- ☞ Press the return key (↵).

A flashing cursor appears below the hours.

- ☞ Set the hours with the arrow keys (↑↓).
- ☞ Press the return key (↵), the cursor jumps to the minutes display.
- ☞ Set the minutes with the arrow keys (↑↓).
- ☞ Press the return key (↵) to confirm.

The input address for the remote contact can be set in various control modes.

Idle key

The idle key on the control panel can be deactivated to prevent unauthorised use.

- ☞ Press the arrow keys (↑↓) until “idle key: y/n” appears in the third line of the display.
- ☞ Press the return key (↵).
- ☞ Select idle key active “y” or inactive “n” with the arrow keys (↑↓).
- ☞ Confirm with the return key (↵).

7.3.3 Control mode

(main menu → configuration → control mode)

- ☞ Keep pressing the arrow keys (↑↓) in the control mode menu option until “local mode” appears in the second line of the display and then press the return key (↵).

Sigma Control is provided with several control modes.

- ☞ Press and hold the arrow keys (↑↓) in local mode until the control mode appears in the third line of the display.
- ☞ Press the return key (↵).
- ☞ Select the required control mode with the arrow keys (↑↓).

The following control modes can be selected:

› **DUAL** › **QUADRO**
› **VARIO** › **Continuous**

- ☞ Press the return key (↵) to confirm the selection.

This activates the selected control mode!

7.3.3.1 DUAL Control settings (normal control)

(main menu → configuration → control mode) → dual)

- ☞ Keep pressing the arrow keys (↑↓) in the “control mode” menu option until “* Dual” appears in the third line of the display below the option “settings” and then press the return key (↵).
- Idle setting in **DUAL** control
 - ☞ Keep pressing the arrow keys (↑↓) until “t = ...s” appears in the third line of the display and then press the return key (↵).
 - ☞ Set the required idle period with the arrow keys (↑↓), taking the minimum period allowed into account, and confirm with the return key (↵).

The minimum idle period in **DUAL** control is 450 s.

7.3.3.2 QUADRO control settings

- ☞ Press the arrow keys (↑↓) until “* Quadro” appears in the third line of the display and then press the return key (↵).
- Setting the unloaded period
 - ☞ Press and hold the arrow keys (↑↓) until “unloaded period” appears in the second and “t= ... s” in the third line of the display. Press the return key (↵).
 - ☞ Set the required unloaded period with the arrow keys (↑↓), taking the minimum period allowed into account, and confirm with the return key (↵).
- Minimum unloaded period
 - ☞ Scroll with the arrow up key (↑) until “unloaded period” appears in the third line of the display and then press the return key (↵) to display the minimum unloaded period.
- Running period setting
 - ☞ Press and hold the arrow keys (↑↓) until “running period” appears in the second and “t= ... s” in the third line of the display. Press the return key (↵).
 - ☞ Set the required running period with the arrow keys (↑↓), taking the minimum period allowed into account, and confirm with the return key (↵).
 - minimum running period
 - ☞ Scroll with the arrow up key (↑) until “running period” appears in the third line of the display and then press the return key (↵) to display the minimum running period.

7.3.3.3 Modulating control

(main menu → configuration → control mode → modulating valve)

- ☞ Keep pressing the arrow keys (↑↓) in the “control mode” menu option until “mod. valve” appears in the third line of the display and then press the return key (↵).

Modulating control is a mechanical form of control.

The inlet valve opens more or less under the influence of a pneumatic controller.

The valve can be regulated either by system pressure or the pressure in the oil separator tank.

- Cut-out point of the modulating control valve
 - ☞ Keep pressing the arrow keys (↑↓) until “pN SP: ...bar” appears in the third line of the display and then press the return key (↵).
 - ☞ Set the required cut-out pressure with the arrow keys (↑↓) and confirm with the return key (↵).

Note

One of these two alternatives is selected by a solenoid valve according to system pressure.

- Switching differential
 - ☞ Keep pressing the arrow keys (↑↓) until “-SD: ...bar ” appears in the third line of the display and then press the return key (↵).
 - ☞ Set the required switching differential with the arrow keys (↑↓) and confirm with the return key (↵).
- Modulating control valve address

The current output address of the modulating valve is shown in the third line of the display.

7.3.4 Acknowledgement (reset)

(main menu → configuration → acknowledgement)

- ☞ Keep pressing the arrow keys (↑↓) in the “configuration” menu option until “acknowledgement” appears in the third line of the display and then press the return key (↵).

In this menu option the settings for remote acknowledgement of a message are found.

- Select remote ackn. input

- ☞ Scroll the option “remote ackn.” into the second line of the display with the arrow keys (↑↓).

The following display appears:

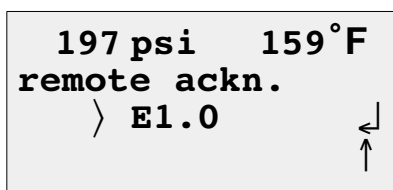

197 psi 159°F
remote ackn.
> E1.0

The screenshot shows a four-line display. The first line contains '197 psi' and '159°F'. The second line contains 'remote ackn.'. The third line contains '> E1.0'. The fourth line contains a left-pointing arrow above a vertical cursor bar.

- ☞ Press the return key (↵).

A flashing cursor appears below the input address.

- ☞ select an input with the arrow keys (↑↓).

- ☞ Confirm the selection with the return key (↵).

- Activating the remote key

- ☞ Scroll the option “remote key” into the third line of the display with the arrow keys (↑↓) and then press the return key (↵).

- ☞ Select “act.: y” (yes) or “act.: n” (no) with the arrow keys (↑↓).

- ☞ Confirm the selection with the return key (↵).

7.3.5 Compressor start

(main menu → configuration → compressor start)

- ☞ Keep pressing the arrow keys (↑↓) in the “configuration” menu option until “compressor start” appears in the third line of the display and then press the return key (↵).

The following settings can be made in this menu option:

- **compressor ON**

- delay time td: ... s

If several compressors start together there is danger of overloading the power supply.

To prevent this, each compressor package can be allocated a start delay time. This allows the compressor packages to start at staggered intervals.

- ☞ Keep pressing the arrow keys (↑↓) until “ td: ...s ” appears in the third line of the display below “compressor ON” and then press the return key (↵).
- ☞ Set the required delay time with the arrow keys (↑↓) and confirm with the return key (↵).
- ☞ Press the return key (↵) when “compressor ON” appears in the third line of the display.

The time at which the compressor packages are started can be set in this menu option. Also, it can be differentiated between “local” and “remote”, i.e., direct control

- local mode:

The compressor package can be started locally with the ON key (Ⓢ) and additionally by the clock.

- ☞ Press and hold the arrow keys (↑↓) in the compressor start menu option until “compressor ON” appears in the third line of the display.
- ☞ Press the return key (↵).
- ☞ Scroll with the arrow keys (↑↓) until “local mode” appears in the second line of the display.
- ☞ Press the return key (↵).

A flashing cursor appears below the operating mode.

- ☞ Select either “key” or “key + clock”.

In the “key” mode the compressor package is started with the ON key (Ⓢ). In the “key + clock” mode the compressor package is additionally started by the internal clock.

- ☞ Enter the selection with the return key (↵).
- ☞ Press the arrow down key (↓) until “clock key” appears in the third line of the display.
- ☞ Press the return key (↵).
- ☞ Select clock key active “y” or inactive “n” with the arrow keys (↑↓).

This protects against unauthorised use.

- ☞ Confirm with the return key (↵).

- remote mode:

Note

To start in remote mode the controller must be switched on with the ON key (ⓘ) and remote mode selected.

The following switching sources can be used:

- remote contact (RC)
- clock or remote contact (cRC)

The procedure is exactly the same as for “local mode” settings. The remote key and the clock key can be activated or deactivated.

The remote contact input can be selected further down in the menu options.

☞ Press the arrow down key (↓) until “* comp. ON” appears in the second line and “RC > I...” appears in the third line of the display.

☞ Press the return key (↵).

The cursor flashes below the input.

☞ Select a suitable input for the remote contact with the arrow keys (↑↓).

☞ Enter the selection with the return key (↵).

- **compressor OFF**

Venting: y/n

The compressor shutdown venting function (unloaded start) is activated in this menu.

☞ Press the return key (↵) when “venting” appears in the third line of the display.

☞ Select “y” (yes) or “n” (no) with the arrow keys (↑↓).

☞ Confirm the selection with the return key (↵).

- **automatic restart after a power supply failure**

When this function is activated the compressor package starts again automatically when power returns after a power failure.

Note

This function is normally activated.

☞ Press the return key (↵) when “restart” appears in the third line of the display.

☞ Select “y” (yes) or “n” (no) with the arrow keys (↑↓).

☞ Confirm the selection with the return key (↵).

- **starting temp.**

To prevent damage to the compressor package caused by starting at a temperature that is too low, a minimum starting temperature of 2 °C is set and the function activated in this menu option.

7.3.6 I/O periphery

(main menu → Configuration → I/O periphery)

- ☞ Keep pressing the arrow keys (↑↓) in the “configuration” menu option until “I/O periphery” appears in the third line of the display.
- ☞ Press the return key (↵).

The submenus are described below:

- clock contact

- ☞ Press the return key (↵) when “clock contact” appears in the third line of the display.

The following display appears:

```
109 psi 185°F
contact day ↵
contact week ↑
```

The procedure for setting up the day, week and year schedules is exactly the same as for the clock (see chapter 7.2.1).

Note Four switching points are available.

- ☞ Press the return key (↵) when “contact day” appears in the third line of the display.

The following display appears:

```
109 psi 185°F
1 | contact day
ON: 00:00 ↵
OFF: 00:00 ↑
```

- ☞ Press the return key (↵) when the parameter to be set appears in the third line of the display.

A flashing cursor appears below the time.

- ☞ Set the hours with the arrow keys (↑↓).
- ☞ Press the return key (↵), the cursor moves to the minutes display.
- ☞ Set the minutes with the arrow keys (↑↓).
- ☞ Press the return key (↵) to enter the new switching points.

- show quantities
 - selecting quantities
 - ☞ Keep pressing the arrow keys (↑↓) in the “I/O periphery” menu option until “show quantities” appears in the third line of the display.
 - ☞ Enter the list of individual quantities with the return key (↵).

There are two displays each for pressure, temperature and other physical quantities available.

- ☞ Press the return key (↵) when the required quantity appears in the third line of the display.

The denotation of the quantity can be individually adapted.

- ☞ Set the amperage with the arrow keys (↑↓).
- ☞ Confirm with the return key (↵).

- message text

- ☞ Scroll the message text into the third line of the display with the arrow down key (↓).
- ☞ Press the return key (↵), a cursor appears below the first character of the message text.
- ☞ Search through the character set with the arrow keys (↑↓) for another character. Confirm this character with the return key (↵) and the cursor will move to the next character in the text.

The message text can consist of up to 15 characters.

- ☞ When all characters have been selected, confirm with the return key (↵).

- selection of sensor input

- ☞ The sensor input for this message is determined by scrolling the required input into the third line of the display.
- ☞ Press the return key (↵), a cursor appears under the corresponding input or its non-activation (n.a.) is displayed.
- ☞ Select a suitable input with the arrow keys (↑↓).
- ☞ Confirm with the return key (↵).

- calibration

- ☞ Scroll in the quantity to be processed with the arrow keys (↑↓) until “calibration” appears in the second line of the display.
- ☞ Press the return key (↵), a cursor appears below the quantity.
- ☞ A definite quantity can now be assigned to the signal input from the sensor.
- ☞ The value of this quantity can be changed with the arrow keys (↑↓).
- ☞ Confirm with the return key (↵).

- external messages

In this menu option the type of message (alarm, service or operational message), the allocation of an input and the delay period for display of the message can be set.

☞ Press the return key (↵), as soon as “ext. messages” appears in the third line of the display, the individual messages are displayed and can be processed.

☞ Scroll the parameter to be set into the third line of the display with the arrow keys (↑↓).

- message text

☞ Scroll the message text into the third line of the display with the arrow keys (↑↓).

☞ Press the return key (↵), a cursor appears below the first character of the message text.

☞ Search through the character set with the arrow keys (↑↓) for another character. Confirm this character with the return key and the cursor will move to the next character in the text.

The message text can consist of up to 15 characters.

☞ When all characters have been selected, confirm with the return key (↵).

- type of message

☞ Press the arrow down key (↓) to determine the type of message.

☞ Press the return key (↵), a cursor appears below the message type, which can be changed with the arrow keys (↑↓).

☞ Confirm with the return key (↵).

- Selection of switched input

☞ Press the arrow down key (↓) to change the switched input.

☞ Press the return key (↵), a cursor appears below the input designation.

☞ This can be changed with the arrow keys (↑↓).

☞ Confirm with the return key (↵).

- delay period

☞ Press the arrow down key (↓) to change the delay period.

☞ Press the return key (↵), a cursor appears below the delay period.

☞ A period between 0 and 600 seconds can be set with the arrow keys (↑↓).

☞ Confirm with the return key (↵).

7.3.6.1 timer

(main menu → configuration → timer)

A solenoid valve for the drainage of condensate can be activated at regular intervals.

☞ Press the arrow keys (↑↓) until “timer” appears in the third line of the display and then press the return key (↵). The timer output is located below.

- OFF period

☞ Press the arrow keys (↑↓) until “OFF” appears in the third line of the display and then press the return key (↵).

☞ Set the required time period with the arrow keys (↑↓) and confirm with the return key (↵).

- ON period

☞ Press the arrow keys (↑↓) until “ON” appears in the third line of the display and then press the return key (↵).

☞ Set the required time period with the arrow keys (↑↓) and confirm with the return key (↵).

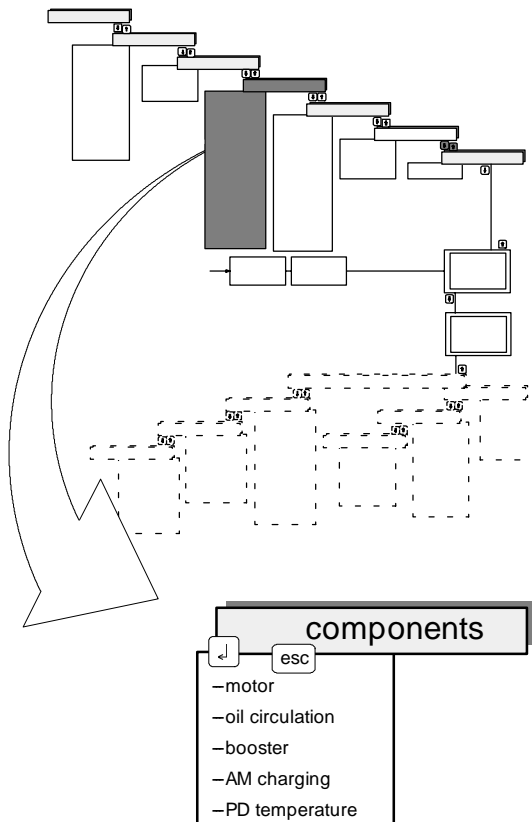
7.4 Components**Display and set up of the components**

- ☞ In the main menu, press and hold the arrow up key (↑) until “components” appears in the third line of the display.
- ☞ Press the return key (↵), the following display appears:

```
109 psi 185°F
motor
access doors ↵
```

7.4.1 Motor

(main menu → components → motor)

☞ Keep pressing the arrow keys (↑↓) in the “components” menu option until “motor” appears in the third line of the display.

☞ Press the return key (↵).

The submenu “power switching” appears in the display.

7.4.1.1 Power switching

(main menu → components → motor → power switching)

The type of motor start and the corresponding settings are entered in this menu option.

- **Display of power switching**

☞ Press the return key (↵).

The selected type of motor start is displayed.

The following modes are available:

- star – delta start
- direct – online – start
- high tension
- soft start
- VFD compressor

- **Setup of power switching**

The types of motor start are repeated under the “settings:” menu option.

☞ Set the required type of motor start with the arrow keys (↑↓) and confirm with the return key (↵).

The parameters for the respective type of motor start can be set in this menu option.

7.4.2 Oil circulation

☞ Press the return key (↵) when “oil circulation” appears in the third line of the display in the “components” menu option.

A submenu with the following menu option opens:

oil separator

7.4.2.1 Oil separator

☞ Press the return key (↵) when “oil separator” appears in the third line of the display in the “oil circulation” menu.

The inputs for the temperature and differential pressure transducers on the oil separator together with the delay period for an excessive differential pressure alarm are displayed.

☞ Press the return key (↵) when “diff. pressure” appears in the third line of the display.

☞ Press the return key (↵) when “> × switch” appears in the third line of the display.

The input allocation for the oil separator pressure transducer is set in this menu option.

☞ Press the arrow down key (↓) until “td:s” appears in the third line of the display.

☞ Press the return key (↵), a cursor appears below the delay period.

- ☞ Set the required delay period with the arrow keys (↑↓).
- ☞ Confirm with the return key (↵).
- ☞ Return to the main menu with the “esc” key.
- ☞ Press the return key (↵) when “temperature” appears in the third line of the display.
The input allocation for the oil separator temperature transducer is set in this menu option.
- ☞ Return to the main menu with the “esc” key.

7.4.3 Booster

- ☞ Press the return key (↵) when “booster” appears in the third line of the display in the “components” menu.

The pressure switching point and the pressure switching differential for a booster can be set in this menu option.

Because a booster only works efficiently above a certain minimum pressure it should be cut in only after achieving this pressure.

The output controlling the booster is also displayed.

- ☞ Press the arrow down key (↓) until “SP:bar” appears in the third line of the display.
- ☞ Press the return key (↵), a cursor appears below the pressure value.
- ☞ Set the required pressure switching point with the arrow keys (↑↓).
- ☞ Confirm with the return key (↵).
- ☞ Press the arrow down key (↓) until “–SD:bar” appears in the third line of the display.
- ☞ Press the return key (↵), a cursor appears below the pressure value.
- ☞ Set the required switching differential with the arrow keys (↑↓).
- ☞ Confirm with the return key (↵).
- ☞ Return to the main menu with the “esc” key.

7.4.4 Air main charging

- ☞ Press the return key (↵) when “AM charging” appears in the third line of the display in the “components” menu.

The pressure switching point and the pressure switching differential for air main charging of an empty air main can be set in this menu option.

A valve is located upstream of the empty air main that first opens when the working pressure has been reached. The output controlling the valve is displayed.

- ☞ Press the arrow key (↓) until “SP:bar” appears in the third line of the display.
- ☞ Press the return key (↵), a cursor appears below the pressure value.
- ☞ Set the required pressure switching point with the arrow keys (↑↓).
- ☞ Confirm with the return key (↵).
- ☞ Press the arrow key (↓) until “–SD:bar” appears in the third line of the display.
- ☞ Press the return key (↵), a cursor appears below the pressure value.
- ☞ Set the required switching differential with the arrow keys (↓).
- ☞ Confirm with the return key (↵).
- ☞ Return to the main menu with the “esc” key.

7.4.5 Package discharge temperature

- ☞ Press the return key (↵) when “PD temperature” appears in the third line of the display in the “components” menu.

The analog input for the transducer is set in this menu option.

- ☞ Press the arrow down key (↓) until “PD temperature” appears in the second line of the display.
- ☞ Press the return key (↵), a cursor appears below the displayed input.
- ☞ Select the required input with the arrow keys (↑↓).
- ☞ Confirm with the enter key (↵).

The pressure switching points and switching differentials for the high or low package discharge temperature alarm and warning messages can be set in this menu option.

- ☞ Press the arrow down key (↓) until “SP:bar” appears in the third line of the display.
 - ☞ Press the return key (↵), a cursor appears below the pressure value.
 - ☞ Set the required pressure switching point with the arrow keys (↑↓).
 - ☞ Confirm with the return key (↵).
 - ☞ Press the arrow down key (↓) until “-SD:bar” appears in the third line of the display.
- A message delay period can be set in this option.

7.5 Package Test

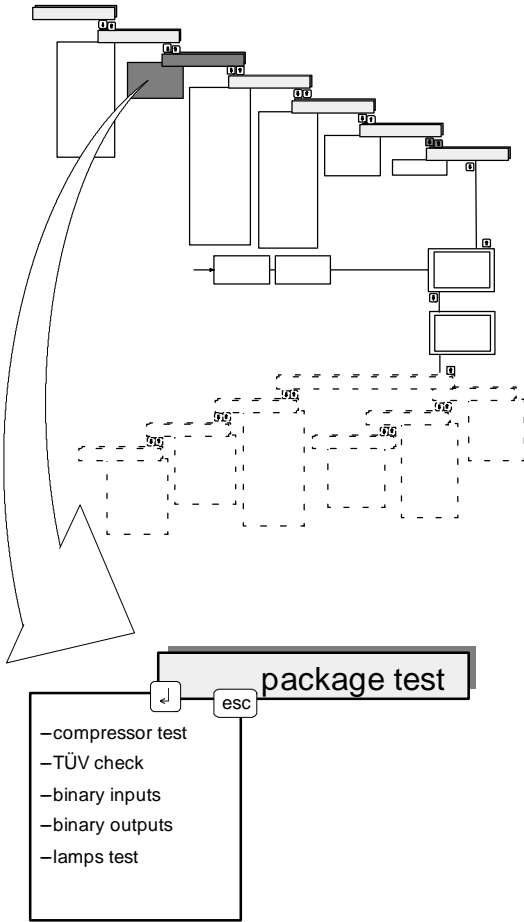

Display and set up of the package test

(main menu → package test)

- ☞ In the main menu, press and hold the arrow up key (↑) until “package test” appears in the third line of the display.
- ☞ Press the return key (↵).

The following display appears:

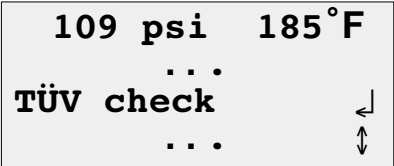

7.5.1 Compressor test

(main menu → package test → compressor test)

- ☞ Press and hold the arrow up key (↑) until the following display appears.

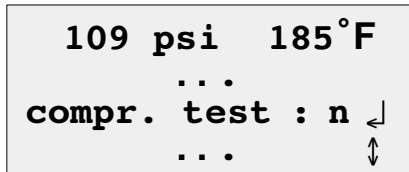

This option shows whether compressor test is activated or not.

7.5.2 TÜV check

(main menu → package test → TÜV check)

- ☞ Press and hold the arrow keys (↑↓) until “TÜV check” appears in the third line of the display.
- ☞ Press the return key (↵).

The submenu is divided into the following options:

7.5.2.1 Pressure relief valve

- ☞ Press and hold the arrow keys (↑↓) until “relief valve: n” appears in the third line of the display.

The pressure relief valve can be checked for correct function using the following procedure:

- ☞ Press the “OFF” key (“0”).
- ☞ Close the ball valve at the output of the package.
- ☞ Press the return key (↵).
- ☞ Press the arrow up key (↑) until the display changes to “relief valve: j”.
- ☞ Confirm with the return key (↵).
- ☞ Press and hold the “ON” (“I”) key until the pressure relief valve opens. As long as the “ON” key is pressed the compressor remains on load and **does not** switch to idle mode even if the nominal package pressure is exceeded. The internal pressure pi that is built up when the pressure relief valve blows is shown in the fourth line of the display.



For safety reasons the function must be deactivated when this check is finished.



Release the ON key immediately after the pressure relief valve opens because of escaping oil mist.

7.5.2.2 Temperature sensor / shutdown temperature

- ☞ Press and hold the arrow keys (↑↓) until “ADT alarm” appears in the third line of the display.
- ☞ Shut down the compressor package and wait until the airend temperature has fallen by around 10 °F. The offset value is determined by subtracting the actual airend temperature from 230 °F.

Example:

- operational airend discharge temperature: 180 °F
- airend discharge temperature after cooling: 170 °F
- offset value: 230 °F minus 180 °F = 50 °F

- ☞ Press the arrow keys (↑↓) until “offset= ... °F” appears in the third line of the display and then press the return key (↵).
- ☞ Enter the evaluated offset value with the arrow keys (↑↓) and confirm with the return key (↵).
- ☞ Press and hold the arrow up key (↑) until “ADT alarm:n” appears in the third line of the

Check the temperature sensor for correct function.

- ☞ Press the OFF key (“0”).
- ☞ Press the return key (↵).
- ☞ Press the arrow up key (↑) until the display changes to “ADT alarm: y”.
- ☞ Confirm with the return key (↵) .
- ☞ Press and hold the ON (“I”) key and switch the compressor package to load. The ADT display now shows the total temperature (airend discharge temperature + offset). If the airend discharge temperature climbs to the previous temperature, the compressor package will shut down at 230 °F because of the offset. The temperature prevailing at shutdown is displayed in the fourth line of the display by pressing the arrow down key (↓) (ADT).
- ☞ Press and hold the arrow keys (↑↓) until “offset= ... °F” appears in the third line of the display and then press the return key (↵).
- ☞ Reset the offset value to 105 °F with the arrow keys (↑↓) and enter with the return key (↵).



For safety reasons the function must be deactivated when this check is finished.

7.5.3 Binary input/output check

(main menu → package test → binary inputs)

(Main menu → Package test → Binary outputs)

- ☞ Press and hold the arrow keys (↑↓) until “binary inputs” or “binary outputs” appear in the third line of the display.
- ☞ Press the return key (↵).

The current binary states of the digital inputs and outputs are shown.

Example:

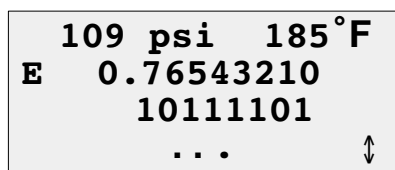

The binary status should be interpreted as follows:

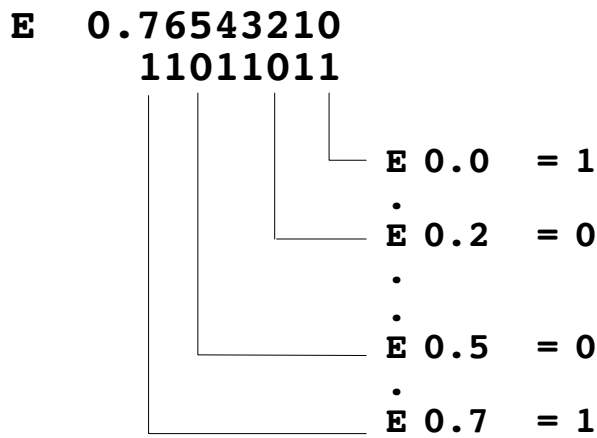

7.5.4 Lamps test

☞ Press and hold the arrow keys (↑↓) until “lamps test” appears in the third line of the display.
The following display appears:

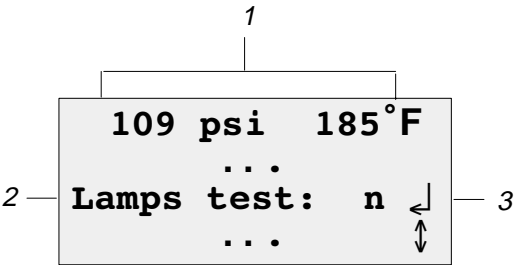

- 1 Current system pressure and airen discharge temperature
- 2 Description of check to be made
- 3 Activation of above test

- ☞ Press the return key (↵).
- ☞ The setting can be changed from “n’ (no) to “y’ (yes) by pressing the arrow key (↑).
- ☞ Press the return key (↵) to confirm the change.

All LEDs on SIGMA CONTROL should flash.

Note In case of malfunction contact an authorised KAESER agent.

The display automatically returns to “lamps test: n” after approximately 10 seconds.

7.6 Communication

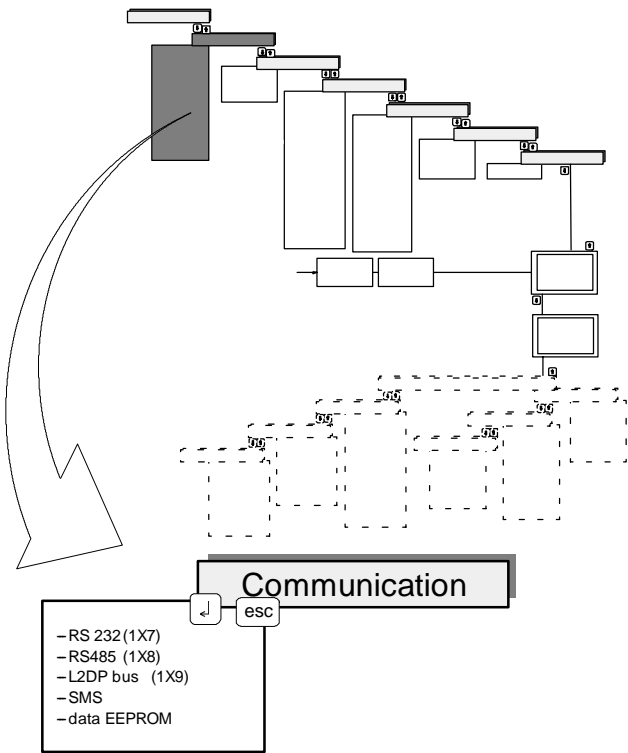

Display of and settings for the interfaces (communication menu)

- ☞ Press and hold the arrow up key (↑) until “communication” appears in the third line of the display.
- ☞ Press the return key (↵).

The following interfaces are listed:

- RS232:
Provides an interface to programming equipment (e.g. AS 511), a modem, a printer, etc.
- RS485:
Allows two compressors to be sequenced (master–slave).
- L2DP bus (Profibus):
Provides an interface to a master control system (control centre, PC, PLC).

All the parameters entered are permanently stored in the EEPROM even if the power supply fails.

The following display options are possible:

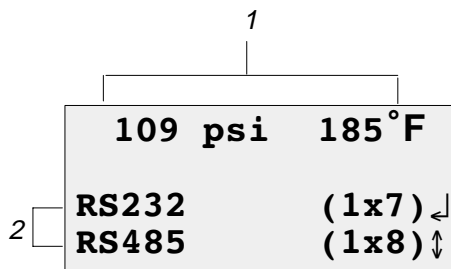

- 1 Current system pressure and air end discharge temperature
- 2 List of interfaces

7.6.1 RS 232 interface

The RS 232 is a serial interface that is required for several functions.

Some examples are programming of the controller, an interface for the printer or modem.

- ☞ Press the return key (↵) when RS 232 is in the third line of the display, the RS 232 menu option opens.

Function

A function can be allocated to the RS 232 in this menu option or the allocated function is displayed.

- ☞ Press the arrow keys (↑↓) until the function [printer, modem, programming unit (AS511)] appears in the third line of the display.
- ☞ Press the return key (↵).
The cursor appears below the current function.
- ☞ Press and hold the arrow keys (↑↓) until the required function for this interface is set.
- ☞ Confirm with the enter key (↵).

Bitrate

- ☞ Press and hold the arrow down key (↓) until the bitrate appears in the third line of the display.
- ☞ Press the return key (↵).
- ☞ Press and hold the arrow keys (↑↓) until the required bitrate appears in the third line of the display.
- ☞ Confirm with the return key (↵).

Format

- ☞ Press and hold the arrow keys (↑↓) until “format” appears in the third line of the display.
The current character frame is shown in the third line of the display.
- ☞ Press the return key (↵).
- ☞ Press and hold the arrow keys (↑↓) until the required format is set.
- ☞ Confirm with the return key (↵).
- ☞ Finally, accept the settings as detailed in chapter 7.6.5.

7.6.2 RS 485 interface

The RS 485 interface is used for the master–slave function. The settings for bitrate and format must be the same for both master and slave.

Function

A detailed description of this function is given in chapter 4.

- ☞ Press and hold the arrow keys (↑↓) until either “master or slave or n.a.”, as required, appears in the third line of the display.
- ☞ Press the return key (↵).
- ☞ Select the required function with the arrow keys (↑↓) and confirm with the return key (↵).

Bitrate

- ☞ Press and hold the arrow keys (↑↓) until the preset bitrate is displayed.

Format

- ☞ Press and hold the arrow keys (↑↓) until “format” appears in the third line of the display.
The current character frame is shown in the third line of the display.
- ☞ Press the return key (↵).
- ☞ Press and hold the arrow keys (↑↓) until the required format appears in the third line of the display.
- ☞ Confirm with the return key (↵).

Remote key

If the compressor package is to be controlled by a master controller via the RS 485 interface the remote key must be set to “y”.

- ☞ Press and hold the arrow keys (↑↓) until “remote key” appears in the third line of the display.
- ☞ Press the return key (↵).
- ☞ Press and hold the arrow keys (↑↓) until the remote key is set to yes or no, as required.
- ☞ Confirm with the return key (↵).
- ☞ Finally, accept the settings as detailed in chapter 7.6.5.

7.6.3 L2DP bus (Profibus)

- ☞ Keep pressing the arrow keys (↑↓) until “L2DP bus” appears in the third line of the display and then confirm with the return key (↵).

An example of a VESIS application is to be found in chapter 4.

Function

This option shows whether the Profibus is active or not.

- ☞ Press the return key (↵) when the first entry appears in the third line of the display.
- ☞ Select the options “not active (n.a.)” or “send” or “send and receive (send+ receive)” with the arrow keys (↑↓) and then confirm with the return key (↵).

Slave number

If the compressor package is connected to a profibus system a clear allocation of the master must be evident. This allocation is made with the slave number.

- ☞ Press the arrow keys (↑↓) until “slave no.: ...” appears in the third line of the display and then press the return key (↵).
- ☞ Set the appropriate slave number (2...126) with the arrow keys (↑↓) and confirm with the return key (↵).

Bus alarm

The hardware monitoring function is shown in this menu.

The bus monitoring is deactivated for this period by the bus controller after the mains power supply is switched on.

The software monitoring can be activated in this menu.

Timeout: The bus–master must respond to a Sigma Control signal within this period otherwise an alarm is initiated.

- ☞ Press and hold the arrow keys (↑↓) until “active (act.:) y/n” appears in the second line of the display.
- ☞ Press the return key (↵).
- ☞ Press and hold the arrow keys (↑↓) until active is set to “yes or “no.
- ☞ Confirm with the enter key (↵).

Remote key

If the compressor package is to be controlled by a master controller via the L2DP bus the remote key must be set to “y”.

- ☞ Press and hold the arrow keys (↑↓) until “remote key” appears in the third line of the display.
- ☞ Press the return key (↵).
- ☞ Press and hold the arrow keys (↑↓) until the remote key is set to “yes” or “no”, as required.
- ☞ Confirm with the return key (↵).

7.6.4 SMS

- ☞ Press the arrow keys (↑↓) until "SMS" appears in the third line of the display and then press the return key (↵).

Settings defining transmission of an SMS to the customer service department are made in this menu.

- ☞ Press the arrow down key (↓) once, until "active (act.:)" appears in the third line of the display.
- ☞ Press the return key (↵) and change the "n" to a "y" with the arrow up key (↑).
- ☞ Confirm with the return (↵) key.
- ☞ Further menu options can be accessed with the arrow down key (↓):

- modem

The telephone number of the online modem is entered and the necessary initialisation is carried out in this option.

- location

The responsible Kaeser subsidiary is shown. The customer's name, telephone number and the language in which the SMS is to be sent can be entered in this option.

- channel 1

The telephone number of the responsible call centre, the number of automatic redials and the duration of the pause between two calls is entered in this menu option.

Further, the telephone number of the customer service department responsible and the type of protocol sent in the SMS is shown.

- channel 2

The channel 2 setup is the same as for channel 1.

7.6.5 Saving settings

All important data are stored in an EEPROM that is no-volt safe.

Data are retained even if the buffer battery discharges completely.

If the procedure is activated it takes approximately 30 seconds for the display to change back from "y" to "n".

Attention!

**No changes should be made to the controller when saving data.
Loss of power when saving can lead to loss of data.**

- ☞ Press and hold the arrow keys (↑↓) until "data →EEPROM" appears in the third line of the display. Press the return key (↵) .
- ☞ Change the entry from "n" to "y" with the arrow keys (↑↓).
- ☞ Confirm with the return key (↵).
- ☞ When the display returns to "n" exit the submenu with the "esc" key.

7.7 Languages

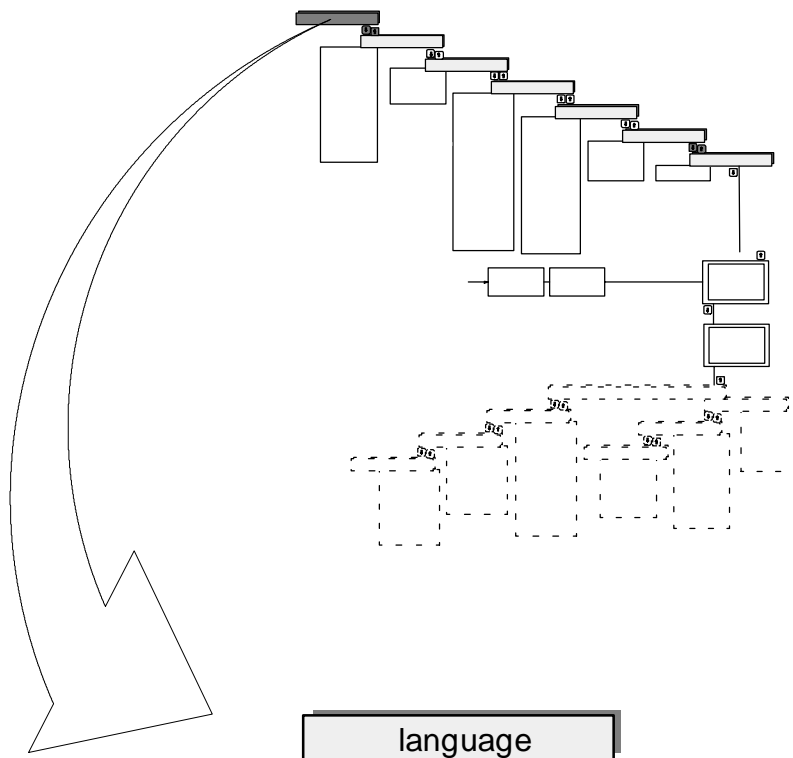

7.7.1 Setting the language

- Press and hold the arrow up key (↑) until the language setting appears in the third line of the display.
- Press the return key (↵).
- Select the required language with the arrow up key (↑).
- Confirm with the return key (↵).
- Return to the main menu with the “esc” key.

7.8 List of Abbreviations

A	alarm or alarm message	no.	number
act	active or activated	O	operational message
ADT	airend discharge temperature		output
AI	analog input	OM	operational message
alm	alarm	op	operation
AM	air main	open cct.	open circuit
an.	analog	os	oil separator
AO	analog output	P	parity
avail	available, already existing	p	pressure, usually airmain
bin.	binary		pressure
blowoff prot	blowoff protection	para	parameter
C	alarm activated, not yet acknowledged	param.	parameter
		PD	package discharge
clk	clock	pE	system pressure increase
ch	characteristic	PDT	package discharge temperature
c/o	changeover	pd	period
comp	compressor	PG	programming function
cont break	continuity break	pi	internal pressure (in oil separator)
cont.	contactor	PN	L2DP
corr	correction	pN	system pressure
cRC	clock remote contact	press.	pressure
D	Dual Control	prot	protection
DI	digital input	profibus	process field bus
diff.	differential	PS	power switching
dir	direction	RAM	random access memory
DO	digital output	RB	remote bus
DOL	direct–online	RC	remote contact
DoR	direction of rotation	RD	refrigeration dryer
DOS	direct–online–start	S	STOP or stop bit
DP	decentral periphery	s	second(s)
dp	delta p (pressure differential)	SD	switching differential
dT	delta T (temperature differen- tial)	SN	serial number
elect.	electrical	Sa	Saturday
equip	equipment	sh.cct	short circuit
ext.	external	SP	switching point
F	FAULT	SSt	soft start device
VFD	variable frequency drive	Su	Sunday
fil	filter	t	time value
Fr	Friday	T	temperature
G	fault rectified, reset alarm	TAP	SMS protocol
h	hours	temp	temperature
hPA	hectapascal	tens.	tension
HT	high tension	Th	Thursday
I	input	tmr	timer
K	Kelvin	UCP	SMS protocol
loc.	local	W	warning, or maintenance message
max	maximum	We	Wednesday
min.	minute	VS	variable speed
min	minimum	y	yes
Mo	Monday	star–delta	star–delta (wye–delta)
MOPS	motor overload protection switch		
n	no (negative answer)		
n.a.	not activated		