

INSTRUCTION MANUAL

Models: KRD25 through KRD75

KAESER

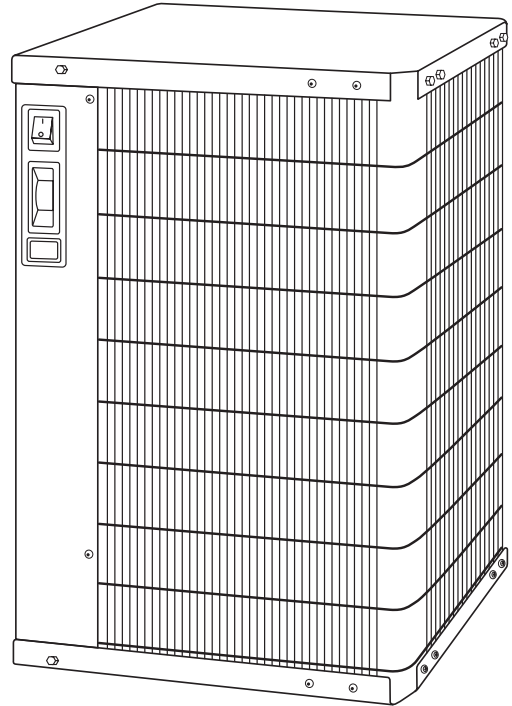

ENGLISH

Contents

SAFETY	2
RECEIVING & INSPECTION	2
HANDLING	2
STORAGE	2
INSTALLATION	3
INSTRUMENTATION	4
CONDENSATE DRAIN VALVE	4
START-UP/OPERATION	4
SHUTDOWN	4
MAINTENANCE/PARTS LIST	5
FIELD SERVICE GUIDE	6
SPECIFICATIONS	7
ELECTRICAL SCHEMATICS	7
FLOW SCHEMATICS	7
WARRANTY	8

KRD SERIES

REFRIGERATED

COMPRESSED

AIR DRYERS

GENERAL SAFETY INFORMATION

1. PRESSURIZED DEVICES:

This equipment is a pressure containing device.

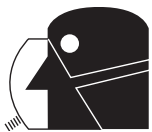

- Do not exceed maximum operating pressure as shown on equipment serial number tag.
- Make sure equipment is depressurized before working on or disassembling it for service.

2. ELECTRICAL:

This equipment requires electricity to operate.

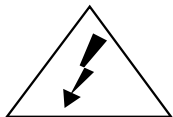

- Install equipment in compliance with all applicable electrical codes.
- Standard equipment is supplied with electrical enclosures not intended for installation in hazardous environments.
- Disconnect power supply to equipment when performing any electrical service work.

3. BREATHING AIR:

- Air treated by this equipment may not be suitable for breathing without further purification. Refer to applicable standards and specifications for the requirements for breathing quality air.

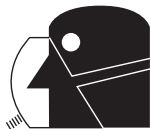

RECEIVING, MOVING, AND UNPACKING

A. RECEIVING

This shipment has been thoroughly checked, packed and inspected before leaving our plant. It was received in good condition by the carrier and was so acknowledged.

Check for visible loss or damage. If this shipment shows evidence of loss or damage at time of delivery to you, insist that a notation of this loss or damage be made on the delivery receipt by the carrier's agent.

B. UNPACKING

Check for concealed loss or damage. When a shipment has been delivered to you in apparent good order, but concealed damage is found upon unpacking, notify the carrier immediately and insist on his agent inspecting the shipment. Concealed damage claims are not our responsibility as our terms are F.O.B. point of shipment.

C. MOVING

In moving or transporting dryer, do not tip dryer onto its side.

D. STORAGE

IMPORTANT: Do not store dryer in temperatures above 130°F.

INSTALLATION

Ambient Air Temperature

Locate the dryer indoors where the ambient air temperature will be between 40°F and 100°F. Intermittent operation at ambient temperatures up to 113°F will not damage the dryer but may result in a higher dew point or dryer shutdown due to high refrigerant discharge pressure (see Field Service Guide).

Do not operate air-cooled dryers at ambient air temperatures below 40°F. Such operation may result in low suction pressure, causing freeze-up.

Call your local distributor if prolonged operation at ambient temperatures above 100°F or below 40°F is unavoidable.

Location and Clearance

Mount the dryer on a level base. Install the dryer in a clean, well-ventilated area to reduce fouling of the condenser coils with dirt and dust.

Vapors and contaminants corrosive to copper and aluminum must not be in the area of the dryer or air compressor intake. Allow at least 6 inches (24 inches on 75 scfm model) clearance from the front and from the condenser coil service access. Install the dryer with the frame level. Anchor bolts are not required.

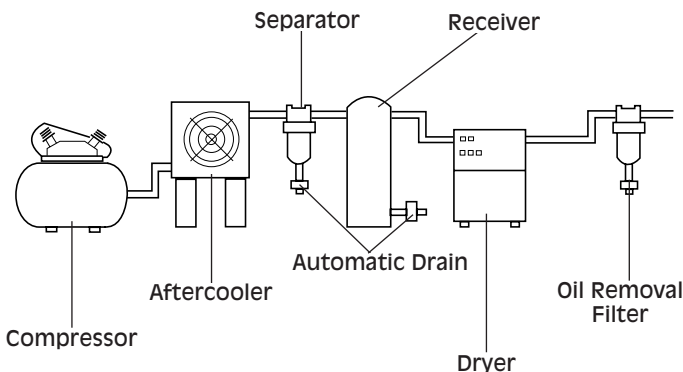

TYPICAL COMPRESSED AIR SYSTEM

System Arrangement

Liquid water in the inlet air will adversely affect the performance of the dryer. Install the dryer downstream of an aftercooler or separator so that the temperature of the dryer inlet air does not exceed 122°F and the inlet air does not contain any liquid water.

Most compressed air systems require filters for removal of solid and liquid contaminants. When an oil-removal filter is used, it should be installed downstream of the refrigerated dryer. The dryer will remove some entrained dirt, extending the life of the replaceable filter element. Outlet air temperature may be 10 to 30 degrees higher than inlet air temperature. This is normal. Consult your distributor if a lower outlet air temperature is required.

Piping and Connections

Piping must be furnished by the user unless otherwise specified. Connections and fittings must be rated for the maximum operating pressure given on the dryer data plate and must be in accordance with applicable codes. Support all piping; do not allow the weight of any piping to stress the dryer or filters. Inlet and outlet shutoff valves and a bypass valve are recommended. Piping should be at least the size of the inlet and outlet connections to minimize pressure drop in the air system. See Engineering Data section for dryer inlet and outlet connections.

Removing Condensate

A separator with an automatic drain valve is supplied with each dryer. The user must install a separate discharge line at the drain connection to carry off condensate to an environmentally approved condensate collection/disposal system. Securely anchor drain line to prevent whipping.

If clogging of the automatic drain is a problem, install a particulate filter before the dryer to keep solid particles from entering the dryer. Contact your local distributor for the appropriate particulate filter.

Electrical Connections (See Figure 1)

Dryer is designed to operate on the voltage, phase and frequency listed on the serial number tag. Reference tag prior to making electrical connection. Dryers are supplied with a cord and plug. Install in receptacle of proper voltage.

CAUTION Operation of dryers with improper line voltage constitutes abuse and could affect the dryer warranty

INSTRUMENTATION

ON/OFF Switch

The dryer is equipped with an ON/OFF switch on the front panel. A light signals when the dryer is on.

Color Indicator

All dryers are equipped with a color indicator which indicates dryer conditions as follows:

It is normal for the indicator color to be in the red zone when the dryer is first turned on and then move to the green zone when the dryer reaches its normal operating temperature. If this indicator is in the red zone during normal operation, turn the dryer off to avoid compressor damage. Refer to the Field Service Guide, for additional information, or call your local distributor.

CONDENSATE DRAIN VALVES

An electronic drain valve is supplied to automatically discharge condensate from the dryer. The drain valve and its controls are accessible from the rear of the dryer. The electronic drain valve has two indicators and a test button to help verify operation. Pushing the test button causes the drain port to click open. If either indicator fails to turn on at the proper time, refer to the maintenance section of this manual. Drain valve operation is controlled by an electronic timer. The drain opening can be set from 0.5 sec to 10 sec. The drain cycle can be set from 0.5 min to 45 min.

Electronic Drain Valve Adjustment

To minimize air losses, the drain valve timer should be adjusted to open the drain port just long enough to discharge accumulated condensate. Set the timer so that only air discharges at the end of the open period.

Recommended Drain Settings

Model SCFM	Time	
	Open (sec.)	Closed (Min.)
25	2	10
35	2	10
50	2	10
75	2	20

NOTE: If liquid discharges as the port is closing, set the timer for a shorter cycle or a longer opening. The amount of condensate will vary as ambient conditions and inlet flow rates change.

START-UP/OPERATION

Follow the procedure below to start your dryer. Failure to follow the prescribed start-up procedure will invalidate the warranty. If problems arise during start-up, call your distributor.

⚠WARNING Refer to Serial Number Tag for dryer operating capacity. Do not exceed recommended capacity

Drain connections must be made before the dryer can be operated. The dryers are fully automatic and require no auxiliary controls.

1. Connect inlet and outlet lines to the dryer. Reference dryer indentations and instruction tag for appropriate inlet and outlet connections.
2. Route drain connections to a condensate separator or approved collection point.
3. Turn the on/off switch to on. Double check connections.
4. After the dryer has been running for 30 minutes:
 - a. Check that on/off lighted switch is glowing. If light is not glowing, unplug unit and refer to Field Service Guide for additional information or call your local distributor.
 - b. Check the Color Indicator. If the indicator is in the red zone, unplug the dryer. Refer to the Field Service Guide for additional information, or call your local distributor.
 - c. Confirm that condensate is discharging from the drain. This can only be done when there is air flow through the dryer.

⚠WARNING Reference Serial Number Tag for appropriate power requirement/connection rating. Make other dryer connections prior to connecting power source.

The dryer is designed to run continuously. Let the dryer run even when the demand for compressed air is interrupted; the dryer will not freeze up.

Operating Check Points

1. Power light is on, light is illuminated
2. Condensate is discharging properly
3. Color Indicator is in the Green Zone

SHUTDOWN

When the dryer must be shutdown for maintenance or other reasons, use the following procedure.

1. Turn the power on/off switch to off.
2. Disconnect the main power supply.

If mechanical repairs are to be made or service is performed, vent the internal pressure of the dryer to atmospheric pressure. Restart the dryer according to the start-up instructions.

⚠WARNING Disconnect power supply and depressurize dryer before servicing. Dismantling or working on any component of the compressed air system under pressure may cause equipment failure and serious personal injury.

MAINTENANCE

The dryers require little maintenance for satisfactory operation. Good dryer performance can be expected if the following routine maintenance steps are taken.

⚠ WARNING Disconnect power supply and depressurize dryer before performing any maintenance.

General

For continued good performance of your refrigerated dryer, all refrigeration system maintenance should be performed by a competent refrigeration mechanic.

NOTE: Before corrective maintenance is done during the warranty period, call your local distributor and proceed according to instructions. Refer to the warranty for limits of your coverage.

Daily Maintenance

Check the separator for condensate discharge. If no discharge is evident, depressurize and perform the following:

1. Electric Drain - Clean strainer and/or clean/replace solenoid valve.

Monthly Maintenance

Inspect the condenser coils. Remove accumulated dust and dirt with a soft brush or with air from an OSHA approved compressed air nozzle that limits the discharge pressure to 30 psig.

Electronic Drain Valve Disassembly and Servicing

⚠ CAUTION Do not disassemble drain valve timer or attempt to repair electrical parts. Replace timer if defective.

The drain valve discharges condensate through a full-port drain opening. The valve body may need to be cleaned under conditions of gross particulate contamination.

To disassemble the drain valve body for cleaning and other maintenance:

1. Turn power switch off
2. Disconnect main power supply to dryer
3. Depressurize unit
4. Lock out and tag power supply in accordance with OSHA requirements

⚠ WARNING If power supply is not disconnected and unit is not depressurized before disassembly, serious personal injury and valve damage may result.

5. Remove screw and washer from front of the drain valve.
6. Remove the power supply connector and gasket (with the timer assembly if attached) from the solenoid coil housing. Do not damage or lose the gasket.
7. Remove coil fixing nut and spring washer from top of solenoid coil housing.
8. Lift solenoid coil housing off solenoid core in valve body.
9. Unscrew solenoid core from valve body.

Once the drain valve is disassembled, the following maintenance can be performed.

1. Inspect internal parts of valve body; clean or replace as required.

NOTE: Replace solenoid valve if component damage is observed

2. Remove debris from valve body.
3. Wipe solenoid core components with a clean cloth or blow out debris with compressed air from an OSHA-approved air nozzle that limits its discharge pressure to 30 psig.
4. Check that the plunger assembly is clean and moves freely in housing.
5. If timer is attached to valve body, check electrical continuity across timer assembly.

To reassemble the drain valve, reverse the sequence of the preceding steps. After the drain valve is reassembled, connect the main power supply to the dryer. When the dryer is returned to service, check the drain valve for air or condensate leaks; tighten connections as required to correct leaks. Check the drain cycle; adjust the timer according to the procedure in the drain valve adjustment section.

Replacement Parts

Item	25	35	50	75
Refrigerant Compressor	3149273	3146980	3149274	2149274
Condenser	3149275	3149275	3149275	1283269
Fan Blades	-	-	-	3041954
Fan Motor	-	-	-	3142592
Liquid Receiver/Filter Dryer	1283369	1283369	1283369	1283369
Constant Press. Expansion Valve	3041489	3041489	3041489	3041489
Electronic Drain Valve	3149293	3149293	3149293	3149293
Fan Pressure Switch	-	-	-	3142601
Color Indicator	3041493	3041493	3041493	3041493
On/Off Switch	3041494	3041494	3041494	3041494
Heat Exchanger	3149278	3149279	3149280	3149281
Side Cover (1)	3149283	3149283	3149283	3149284
Side Cover (2)	3149285	3149285	3149285	3149286
Top Cover	3149288	3149288	3149288	3149289
Base Frame	3149291	3149291	3149291	3149292

Returns to Manufacturer

If the dryer or a component of the dryer must be returned to the manufacturer, first call your local distributor for a return authorization number and shipping address. Your distributor will inform you whether the dryer or only a component must be returned. Mark the package with the return authorization number and ship freight prepaid as directed by your local distributor.

FIELD SERVICE GUIDE

Problems most frequently encountered with refrigerated dryers are water downstream of the dryer and excessive pressure drop. Most causes can be identified and remedied by following this guide

⚠WARNING Closed refrigeration systems are potentially dangerous. Work on the refrigeration system must be done only by a competent refrigeration mechanic. Do not release fluorocarbon

refrigerants to the atmosphere. All refrigerants must be recovered per EPA requirements. Do not smoke when a refrigeration leak is suspected. Burning materials may decompose refrigerants, forming a toxic gas or acids that may cause serious injury and property damage. Before dismantling any part of the dryer or compressed air system, completely vent the internal pressure to the atmosphere.

PROBLEM	POSSIBLE CAUSE	REMEDY
WATER DOWNSTREAM OF DRYER		
SYMPTOM: No discharge from separator drain	Failure of drain	Dismantle & clean strainer, repair or replace solenoid valve
SYMPTOM: Dryer inlet air temperature too high	Aftercooler malfunction	Check aftercooler discharge temperature and reduce to dryer design condition (122°F max)
SYMPTOM: Refrigerant compressor stopped	Leak in refrigeration system	Consult your local distributor
	Compressor overheated	Turn dryer off, wait 30 minutes; turn dryer on. (Motor thermostat self-starting)
	Compressor burned out	Consult your local distributor
HIGH PRESSURE DROP		
SYMPTOM: Low outlet pressure	Dryer undersized (may also cause water downstream of dryer)	Check airflow and dryer capacity. Reduce airflow or resize and replace dryer
	Dryer icing up (check at separator)	Consult your local distributor
COLOR INDICATOR OUT OF GREEN ZONE		
SYMPTOM: Indicator in red zone	Inlet air temperature too high	Reduce aftercooler discharge temperature to design conditions (See Engineering Data)
	Excessive airflow	Check airflow & system capacity. Reduce airflow or resize and replace system
	Condenser fouled or clogged	Clean or replace condenser
	Fan motor inoperative	Replace fan motor (75 scfm model)
	High ambient temperature	Ventilate area
	Improper adjustment of Expansion Valve	Remove cap from the exp. valve and turn the screw until the indicator is in the green zone
	SYMPTOM: Indicator in Blue Zone	Improper adjustment of the Expansion valve
Low ambient temperature		Increase ambient temperature to design conditions

ENGINEERING DATA

SCFM	25	35	50	75
SPECIFICATIONS				
Rated Capacity ^a - (scfm)	25	35	50	75
Inlet /Outlet Connections - (inches)	3/4	3/4	3/4	3/4
Dimensions				
Height - (inches)	22.2	22.2	22.2	29.6
Length - (inches)	15.5	15.5	19.7	27.0
Width - (inches)	14.5	14.5	19.7	18.4
Power Supply - (V/Ph/Hz)	115/1/60	115/1/60	115/1/60	115/1/60
Refrigerant Compressor Rating - (hp)	1/4	1/4	1/3	1/3
Input Power - (kW)	0.47	0.47	0.63	0.65
Refrigerant Type ^b	R-134a	R-134a	R-134a	R-134a

MINIMUM - MAXIMUM OPERATING CONDITIONS

Min.-Max. Inlet Air Pressure (compressed air at inlet to dryer)	30 - 250 psig	30 - 250 psig	30 - 250 psig	30 - 250 psig
Min.-Max. Inlet Air Temperature (compressed air at inlet to dryer)	40°F - 122°F	40°F - 122°F	40°F - 122°F	40°F - 122°F
Min.-Max. Ambient Temperature	40°F - 113°F	40°F - 113°F	40°F - 113°F	40°F - 113°F

^a Rating conditions are 100°F inlet temperature, 100 psig inlet pressure, 100% inlet relative humidity, 100°F ambient temperature @ 60Hz. Per CAGI ADF-100

^b Refer to dryer data plate for refrigerant charge.

ENGLISH

ELECTRICAL SCHEMATICS

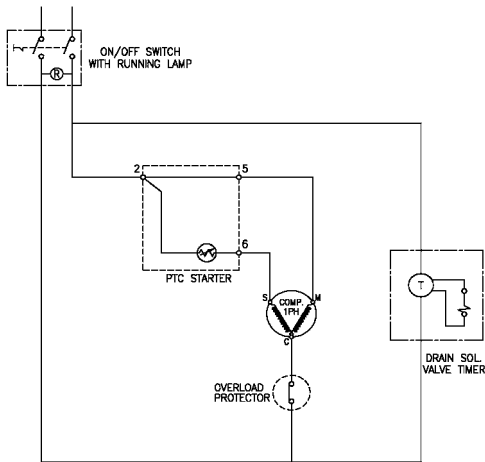

Figure 1a
25 - 50 scfm model

AIR AND REFRIGERANT FLOW SCHEMATICS

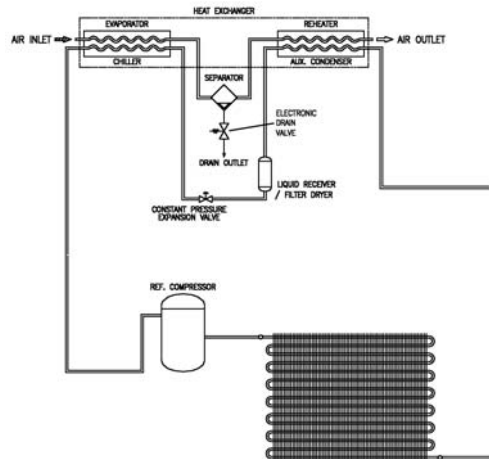

Figure 2a
25 - 50 scfm models

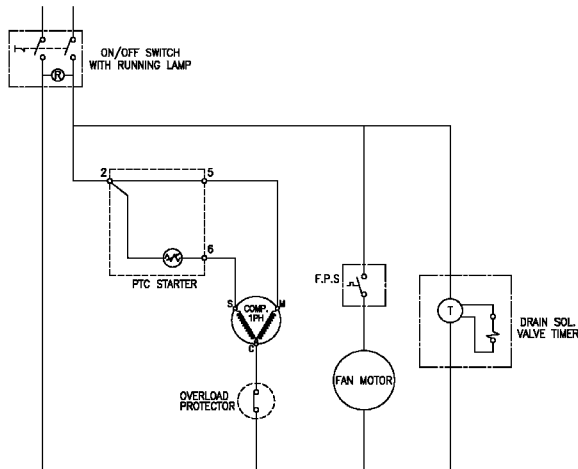

Figure 1b
75 scfm model

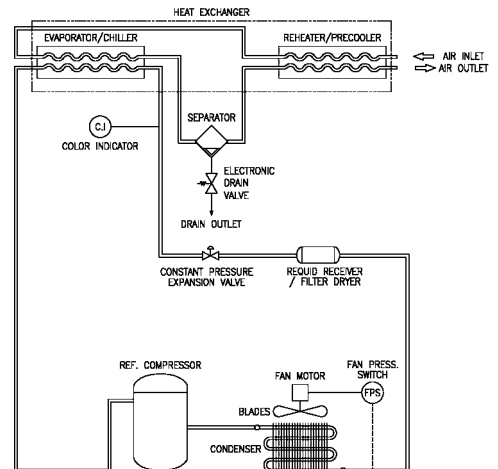

Figure 2b
75 scfm model

WARRANTY

The manufacturer warrants the product manufactured by it, when properly installed, operated, applied, and maintained in accordance with procedures and recommendations outlined in manufacturer's instruction manuals, to be free from defects in material or workmanship for a period as specified below, provided such defect is discovered and brought to the manufacturer's attention within the aforesaid warranty period.

The manufacturer will repair or replace any product or part determined to be defective by the manufacturer within the warranty period, provided such defect occurred in normal service and not as a result of misuse, abuse, neglect or accident. Normal maintenance items requiring routine replacement are not warranted. The warranty covers parts and labor for the warranty period unless otherwise specified. Repair or replacement shall be made at the factory or the installation site, at the sole option of the manufacturer. Any service performed on the product by anyone other than the manufacturer must first be authorized by the manufacturer.

Unauthorized service voids the warranty and any resulting charge or subsequent claim will not be paid. Products repaired or replaced under warranty shall be warranted for the unexpired portion of the warranty applying to the original product.

The foregoing is the exclusive remedy of any buyer of the manufacturer's product. The maximum damages liability of the manufacturer is the original purchase price of the product or part.

THE FOREGOING WARRANTY IS EXCLUSIVE AND IN LIEU OF ALL OTHER WARRANTIES, WHETHER WRITTEN, ORAL, OR STATUTORY, AND IS EXPRESSLY IN LIEU OF THE IMPLIED WARRANTY OF MERCHANTABILITY AND THE IMPLIED WARRANTY OF FITNESS FOR A PARTICULAR PURPOSE. THE MANUFACTURER SHALL NOT BE LIABLE FOR LOSS OR DAMAGE BY REASON OF STRICT LIABILITY IN TORT OR ITS NEGLIGENCE IN WHATEVER MANNER INCLUDING DESIGN, MANUFACTURE OR INSPECTION OF THE EQUIPMENT OR ITS FAILURE TO DISCOVER, REPORT, REPAIR, OR MODIFY LATENT DEFECTS INHERENT THEREIN.

THE MANUFACTURER, HIS REPRESENTATIVE OR DISTRIBUTOR SHALL NOT BE LIABLE FOR LOSS OF USE OF THE PRODUCT OR OTHER INCIDENTAL OR CONSEQUENTIAL COSTS, EXPENSES, OR DAMAGES INCURRED BY THE BUYER, WHETHER ARISING FROM BREACH OF WARRANTY, NEGLIGENCE OR STRICT LIABILITY IN TORT.

The manufacturer does not warrant any product, part, material, component, or accessory manufactured by others and sold or supplied in connection with the sale of manufacturer's products.

Warranty Period

Parts and labor for two (2) years from the date of shipment from the factory; heat exchangers are covered (parts only) for an additional three (3) years (total of five [5]). On units that manufacturer requests be returned to the factory, a one time removal/reinstallation labor allowance as noted in the Service Warranty Policies and Procedures Handbook will apply. Freight to the factory from the installation site and to the installation site from the factory will be paid by the manufacturer; means of transportation to be specified by manufacturer.

2/96

AUTHORIZATION FROM THE SERVICE DEPARTMENT IS NECESSARY BEFORE MATERIAL IS RETURNED TO THE FACTORY OR IN-WARRANTY REPAIRS ARE MADE.

SERVICE DEPARTMENT: (724) 745-3038

KAESER

www.kaeser.com

KAESER COMPRESSORS

U.S.A. • P.O.Box 946 • Fredericksburg, VA 22404 • Tel: 540/898-5500 • Fax: 540/898-5520 • Service: (724) 745-3038

Canada • 3760 Rue La Verendrye • Boisbriand (Quebec) J7H 1R5 • Tel: 450/971-1414 • Fax: 450/971-1415 • Service: (724) 745-3038

KAESER COMPRESORES, S.A. de C.V.

Mexico • Calle 2, No. 111 Locales EYF • Parque Industrial Jurica • 76100 Querétaro, QRO Mexico • Tel: 52-42-18-64-48 • Fax: 52-42-18-64-49

KAESER KOMPRESSOREN

Austria • Ges.m.b.H. • A-4031 Linz, Dallingergstr.8 • Telefon: (43) 732/38 60 51-0 • Fax: (43) 732/38 67 80 • Service: (43) 732/38 60 51-0

Singapore • 81 Tech Park Crescent • Tuas Tech Park • Singapore 638067 • Tel: (65) 68857733 • Fax: (65) 68857700 • 24-Hour Hotline: (65) 96838200